

# marantz®

## Model DR2100 User Guide

---

Compact Disc Recorder

CLASS 1 LASER PRODUCT  
LUOKAN 1 LASERLAITE  
KLASS 1 LASERAPPARAT

COMPACT  
disc  
DIGITAL AUDIO  
Recordable  
ReWritable



For warranty information, contact your local Marantz distributor.

### RETAIN YOUR PURCHASE RECEIPT

Your purchase receipt is your permanent record of a valuable purchase. It should be kept in a safe place to be referred to as necessary for insurance purposes of when corresponding with Marantz.

### IMPORTANT

When seeking warranty service, it is the responsibility of the consumer to establish proof and date of purchase. Your purchase receipt or invoice is adequate for such proof.

### FOR U.K. ONLY

This undertaking is in addition to a consumer's statutory rights and does not affect those rights in any way.

## FRANÇAIS

### GARANTIE

Pour des informations sur la garantie, contactez le distributeur local Marantz.

### CONSERVER L'ATTESTATION D'ACHAT

L'attestation d'achat est la preuve permanente d'un achat de valeur. La conserver en lieu sûr pour s'y reporter aux fins d'obtention d'une couverture d'assurance ou dans le cadre de correspondances avec Marantz.

### IMPORTANT

Pour l'obtention d'un service couvert par la garantie, il incombe au client d'établir la preuve de l'achat et d'en corroborer la date. Le reçu ou la facture constituent des preuves suffisantes.

## DEUTSCH

### GRANTIE

Bei Garantiefragen wenden Sie sich bitte an Ihren Marantz-Händler.

### HEBEN SIE IHRE QUITTUNG GUT AUF

Die Quittung dient Ihnen als bleibende Unterlage für Ihre wertvolle Anschaffung. Das Aufbewahren der Quittung ist wichtig, da die darin enthaltenen Angaben für Versicherungszwecke oder bei Korrespondenz mit Marantz angeführt werden müssen.

### WICHTIG!

Bei Garantiefragen muß der Kunde eine Kaufunterlage mit Kaufdatum vorlegen. Ihre Quittung oder Rechnung ist als Unterlage ausreichend.

## NEDERLANDS

### GRANTIE

Voor inlichtingen omtrent garantie dient u zich te wenden tot uw plaatselijke Marantz-handelaar.

### UW KWITANTIE, KASSABON E.D. BEWAREN

Uw Kwitantie, kassabon e.d. vormen uw bewijs van aankoop van een waardevol artikel en dienen op een veilige plaats bewaard te worden voor evt. verwijzing, b.v. in verband met verzekering of bij correspondentie met Marantz.

### BELANGRIJK

Bij een evt. beroep op de garantie is het de verantwoordelijkheid van

L'apparecchio è garantito per 365 giorni dalla data di acquisto comprovata da un documento attestante il nominativo del rivenditore e la data di vendita. La garanzia sarà prestata con la sostituzione o riparazione gratuita delle parti difettose.

Non sono coperti da garanzia difetti derivanti da uso improprio, errata installazione, manutenzione effettuata da personale non autorizzato o, comunque, da circostanze che non passano riferirsi a difetti di funzionamento dell'apparecchio.

Sono inoltre esclusi dalla garanzia gli interventi inerenti l'installazione e l'allacciamento agli impianti di alimentazione.

Gli apparecchi verranno riparati presso i nostri Centri di Assistenza. Le spese ed i rischi di trasporto sono a carico del cliente.

La casa costruttrice declina ogni responsabilità per danni diretti o indiretti provocati dalla inosservanza delle prescrizioni di installazione, uso e manutenzione dettagliate nel presente manuale.

Per informazioni sull'abbonamento al servizio Assistenza postgaranzia e per conoscere l'indirizzo dei Centri Assistenza Marantz rivolgetevi al nostro servizio consumatori (telefono 1678-20026 - numero verde).

## PORTUGUÊS

### GARANTIA

Para informações sobre a garantia, contactar o distribuidor Marantz local.

### GUARDAR O RECIBO DE COMPRA

O recibo é o registo permanente da compra que fez. Deve ser guardado num local seguro, para ser apresentado em questões relacionadas com o seguro ou para quando tiver de contactar a Marantz.

### IMPORTANTE

Quando procurar assistência técnica ao abrigo da garantia, é da responsabilidade do consumidor estabelecer a prova e data de compra. O recibo é prova adequada.

## ESPAÑOL

### GARANTÍA

Para información sobre las Condiciones de Garantía, sírvase consultar el Certificado que encontrará en le interior del embalaje del equipo.

### CONSERVE EL COMPROBANTE DE LA COMPRA

La factura es el comprobante de la adquisición de un producto valioso. Consérvela en lugar seguro para poder consultarla en caso necesario.

### IMPORTANTE

Para disponer de servicios cubiertos por la garantía, el usuario deberá acreditar la fecha y el lugar de adquisición del equipo. La factura o recibo de la compra constituyen un comprobante válido a tal efecto.

Angående garanti, kontakta din lokala Marantz handlare.

### SPAR KVITTOT

Kvittot är din inköpshandling över inköp av en värdfull vara. Det ska placeras på ett säkert ställe och hänvisas till vid försäkringsfrågor eller vid korrespondens med Marantz.

### VIKTIGT

När garantiservice åberopas är det konsumentens ansvar att visa datum för inköp. Ditt kvitto eller din faktura är ett tillfredsställande bevis.

ENGLISH:  
CAUTION –

USE OF CONTROLS OR ADJUSTMENTS OR PERFORMANCE OF PROCEDURES OTHER THAN THOSE SPECIFIED HEREIN MAY RESULT IN HAZARDOUS RADIATION EXPOSURE.

FINNISH:  
VAROITUS!

Laitteen käytäminen muulla kuin tässä käyttöohjeessa mainittulla tavalla saattaa altistaa käyttäjän turvallisuusluokan 1 ylittävälle näkymättömälle lasersäteilylle.

SWEDISH:  
VARNING!

Om apparaten används på annat sätt än vad som beskrivs i denna bruksanvisning kan användaren utsättas för osynlig laserstrålning som överskrider gränsen för laserklass 1.

## WARNINGS FOR LASER RADIATION

CAUTION : INVISIBLE LASER RADIATION WHEN OPEN. DO NOT STARE INTO BEAM.

DANGER : INVISIBLE LASER RADIATION WHEN OPEN. AVOID DIRECT EXPOSURE TO BEAM.

VARO! : AVATTAESSA JA SUOJALUKITUS OHITETTAESSA OLET ALTTIINANAKYMÄTTÖMÄLLE LASERSÄTEILYLLE. ÄLÄ KATSO SÄTEESEEN.

VARNING! : OSYNLIG LASERSTRÅLNING NÄR DENNA DEL ÄR ÖPPNAD OCH SPÄRREN ÄR URKOPPLAD. BETRAKTA EJ STRALEN.

Henvend dem til Deres MARANTZ-forhandler angående information om garantien.

### GEM DERES KVITTERING

Deres købskvittering er Deres varige bevis på et dyrt køb. Den gemmes godt og anvendes som bevis, hvis De vil tegne en forsikring eller hvis De kommunikerer med Marantz.

### VIGTIGT

Det påhviler forbrugeren at skaffe bevis for købet og købdatoen, hvis han eller hun ønsker garantiservice. Deres købskvittering eller faktura er et fuldydligt bevis herpå.

**OTHER INFORMATIONS** ..... 22  
 Fixing problems ..... 22  
**ABOUT TEXT** ..... 22

**INTRODUCTION** ..... 1  
 Unpacking ..... 1  
 Setup ..... 1  
 Compact discs ..... 1  
 Maintenance ..... 2

**CONTROLS AND CONNECTIONS** ..... 3

**INSTALLATION** ..... 5  
 The following options are available: ..... 5  
 Analog connections ..... 5  
 Digital Coaxial connections ..... 5  
 Digital Optical connections ..... 6  
 Remote control connections ..... 6  
 System connections ..... 6

**USING THE RECORDER** ..... 7  
 Switching ON and OFF ..... 7  
 Using the remote control ..... 7  
 Inserting discs ..... 7

**RECORDING** ..... 8  
 Remarks about recording ..... 8  
 Recording modes ..... 8

**RECORDING (FROM INTERNAL CD-DECK)** ..... 9  
 Double speed recording ..... 9  
 Normal speed recording ..... 10

**RECORDING (FROM EXTERNAL SOURCE)** ..... 11  
 Manual start recording ..... 11  
 CD-SYNC ..... 12

**SYSTEM RECORDING (FROM EXTERNAL SOURCE)** ..... 13  
 System connection recording ..... 13

**FINALIZING/UNFINALIZING** ..... 14  
 Finalizing CD-R & CD-RW discs ..... 14  
 Unfinalizing CD-RW discs ..... 14

**ERASING** ..... 15  
 Erasing ..... 15  
 Erasing one or more tracks from the end ..... 15  
 Erasing the entire disc ..... 15

**PLAYING** ..... 16  
 Playing a 2-disc-changer ..... 16  
 Selecting a track ..... 17  
 Scan play ..... 17  
 Search ..... 17  
 Random play ..... 17  
 Repeat play ..... 17

**PROGRAMMING** ..... 18  
 Programmed play ..... 18

**MENU MODE** ..... 19  
 MENU MODE can set up: ..... 19  
 Text settings ..... 19  
 Recording settings ..... 20

**DISPLAY** ..... 21  
 General ..... 21  
 Recording ..... 21  
 Play ..... 21  
 Others ..... 21

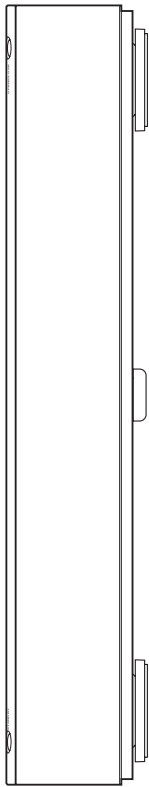

Front when it closed

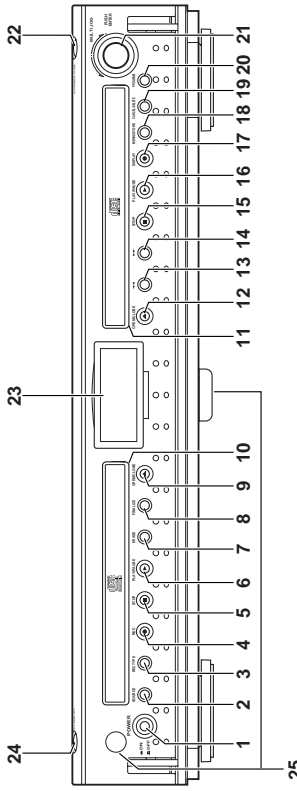

Front when it opened

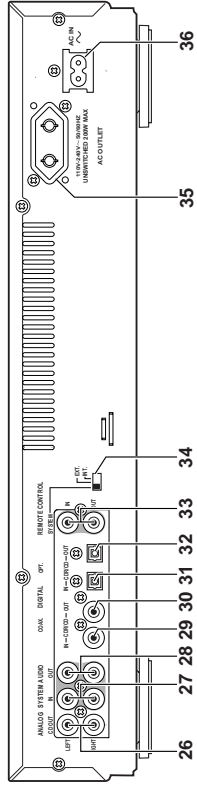

Back

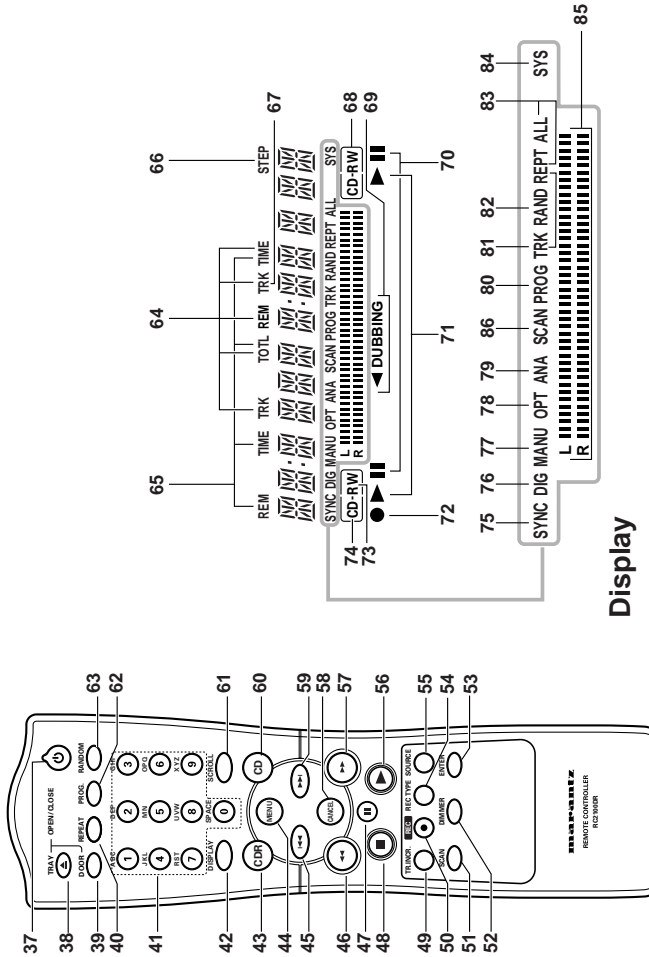

Display

# INTRODUCTION

## Foreword

This section must be read carefully before any connection is made to the mains supply.

### WARNINGS

- Do not expose the equipment to rain or moisture.
- Do not remove the cover from the equipment.
- Do not insert anything into the equipment through the ventilation holes.
- Do not handle the mains lead with wet hands.

## CE marking (only EU version)

 This product is in conformity with the EMC directive and low-voltage directive.

## Equipment mains working system

Your Marantz product complies with the household power and safety requirements in your area.

“N1” Version product can be powered by 230 V AC only.

### IMPORTANT: (FOR/UK. version only)

This apparatus is fitted with an approved moulded 13 Amp plug. To change a fuse in this type of plug proceed as follows:

1. Remove fuse cover and fuse.
2. Fix new fuse which should be a BS1362 5A, A.S.T.A. or BSI approved type.
3. Refit the fuse cover.

If the fitted plug is not suitable for your socket outlets, it should be cut off and an appropriate plug fitted in its place.

If the mains plug contains a fuse, this should have a value of 5A. If a plug without a fuse is used, the fuse at the distribution board should not be greater than 5A.

### Note :

The severed plug must be destroyed to avoid a possible shock hazard should it be inserted into a 13A socket elsewhere.

## HOW TO CONNECT A PLUG

The wires in the mains lead are coloured in accordance with the following code:

BLUE—“NEUTRAL” (“N”)

BROWN—“LIVE” (“L”)

1. The BLUE wire must be connected to the terminal which is marked with the letter “N” or coloured BLACK.
2. The BROWN wire must be connected to the terminal which is marked with the letter “L” or coloured RED.
3. **Do not connect either wires to the earth terminal in the plug which is marked by the letter “E” or by the safety earth symbol  $\perp$  or coloured green or green-and-yellow.**

Before replacing the plug cover, make certain that the cord grip is clamped over the sheath of the lead — not simply over the two wires.

## Copyright

Recording and playback of some material may require permission. For further information refer to the following:

- Copyright Act 1956
- Dramatic and Musical Performers Act 1958
- Performers Protection Acts 1963 and 1972
- Any subsequent statutory enactments and orders

Congratulations on the acquisition of your CD-Recorder. This CD-Recorder now enables you to record, play and erase your own audio Compact Discs. Naturally the recorder can also be used to play all pre-recorded CDs.

With the exception of legal restrictions pertaining to copying, you can now create your own high-quality audio recordings on CD. The discs used to record must bear the logos shown below. Copyright fees have been paid on these discs in some countries. Recording on other types of discs (e.g. CD-R for professional recordings) is not possible.

There are two types of recordable AUDIO discs:

CD-R(W) discs have a compatibility to play/record on the CD-Recorders based on the ORENGE BOOK Part II/III. But the discs might not be able to be played/recorded properly depending on the combinations of the discs and CD-Recorders.

### 1 CD Recordable Audio (record once):

Fully recorded and subsequently finalized audio CD-R discs can be played on all CD players and recorders that are suitable for CD-R discs. A CD-R disc can be recognized by the following logo:



### 2 CD ReWritable Audio (multiple recording):

Recorded and finalized audio CD-RW discs can be played on all CD players and recorders that are suitable for CD-RW discs. An increasing number of players and recorders will be suitable for these discs in the future. A CD-RW disc can be recognized by the following logo:



The CD-R(W)disc for ‘DIGITAL AUDIO’ can be both recording and playing on this CD-Recorder. In addition, this CD-Recorder can play the CD-R(W) disc for ‘PROFESSIONAL RECORDING’, but cannot record it.

Once you start using the recorder, you will discover how easy it is to ‘make’ your own CDs. Nevertheless, we recommend that you use an erasable (CD-RW) digital audio disc on your first attempt, while following the instructions given here.

### Attention!

**Recordings may only be made for personal use.**

**It is forbidden to copy material protected by copyright, including computer programs, films, television and audio recordings. This appliance may not be used for applications of this type.**

### Note:

Some CD players can not play the finalized CD-R(W) discs because of the low reflectivity of such discs.

Because of laser power differences, some DVD players cannot play the finalized CD-R(W) discs.

Read the text carefully and keep the instructions close at hand so that you can refer to them if necessary.

# INTRODUCTION

## Unpacking

First check the contents of the packaging. It should contain the following:

- CD-Recorder DR2100
- Remote control with batteries packaged separately
- Audio cables (2 - with red and white plugs)
- Remote control cable (with orange plugs)
- AC CORD
- Instructions

If one of these components is missing, please inform your supplier immediately. Save the packaging material it may come in handy if you move the appliance.

## Setup

- Place the recorder on a strong, vibration-free surface.
- Do not use the recorder under extremely damp conditions.
- If the recorder is placed in a cabinet, make sure that a 2.5 cm space remains free on all sides of the recorder for proper ventilation.

### Attention!

**If the appliance is not used or operated in accordance with the instructions, this may result in exposure to dangerous radiation or other risks.**

**Only authorized technicians are allowed to open the appliance casing or to perform repairs or maintenance.**

## Compact discs

The glossy side shining like a rainbow is the front side of the disc, and the side on which the label is printed is the back. Unlike conventional turntables for playing analog discs, the DR2100 reads the information recorded on the disc from underneath without contacting it using a beam of laser light. Therefore, the performance of a compact disc will not degrade like conventional analog records.

**Handle discs carefully so as not to damage or scratch the front side.**

**To protect the disc, avoid placing it in the following locations:**

- In direct sunlight or near a source of heat like a heater.
- In a place which is damp or dirty.
- In a place which could be exposed to rain, such as near a window.

### Always keep the disc surface clean.

Up to six billion data units are recorded on the front side of the disc. When cleaning the disc surface, always be sure to use a special compact disc cleaner and wipe as shown below.

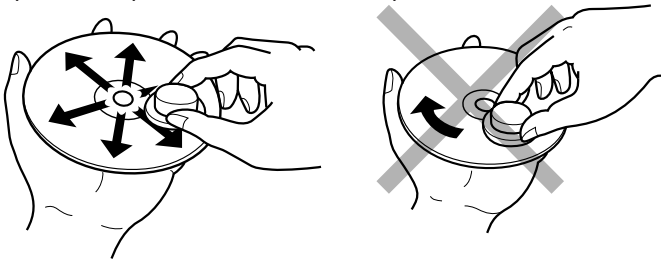

- Do not use conventional record cleaner for analog records, as this will adversely affect the disc surface. Store discs properly by placing them in their disc cases.
- Do not attach a piece of paper or sticker on the label side of disc. When a disc has a piece of plastic tape or rental CD label with paste protruded from the edge or when a disc has a trace of such a sticky object, do not attempt to play the disc. If such a disc is played on the CD player, impossibility of taking out the disc or other malfunction may result.

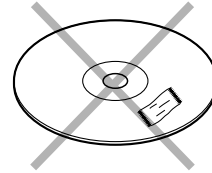

- Write only on the printed side of a CD-R or CD-RW, and only with a soft felt-tipped pen.
- Do not use a disc with a special shape. Do not attempt to play a disc with a special shape such as a heart-shaped disc or octagonal disc. Otherwise the equipment malfunction may result.

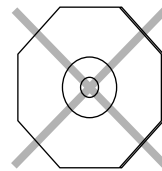
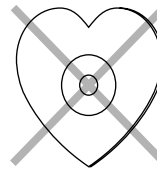

## Maintenance

Clean the CD-Recorder with a soft, slightly dampened lint-free cloth. Do not use any cleaning agents as they may have a corrosive effect.



Do not expose the CD-Recorder, batteries or CDs to humidity, rain, sand or excessive heat (caused by heating equipment or direct sunlight).

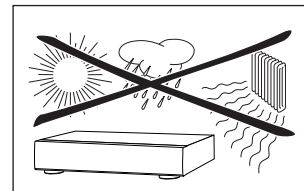

If the CD-Recorder cannot read CDs correctly use a commonly available cleaning CD to clean the lens before taking the CD player to be repaired. Other cleaning methods may destroy the lens. Always keep the tray closed to avoid dust on the lens.

The lenses may cloud over when the CD-Recorder is suddenly moved from cold to warm surroundings. It is not possible to play a CD then. Leave the CD-Recorder in a warm environment until the moisture evaporates.

# CONTROLS AND CONNECTIONS

## Controls on the front

### General

- (1) **POWER ON/OFF** ..... turns the CD-Recorder ON and OFF
- (13) **◀◀** ..... - searches backward  
- cursor control in Menu/Prog. review mode
- (14) **▶▶** ..... - searches forward  
- cursor control in Menu/Prog. review mode
- (17) **DISPLAY** ..... selects display information/text
- (18) **MENU/STORE** ..... - enters Menu mode  
- stores Menu settings
- (19) **CANCEL/DELETE** ..... - deletes tracks from a program  
- deletes text in Menu mode  
- returns to a higher level in the menu
- (20) **PROGRAM** ..... opens/closes program memory
- (21) **- MULTI JOG +** ..... - previous/next track (Play and Program mode)  
- recording level control (recording)  
- selects settings (menu on)
- PUSH/ENTER (push)** ..... - plays selected tracks  
- selects settings in Menu mode  
- programs track numbers
- (22) **OPEN/CLOSE** ..... opens/closes front door
- (23) **Display** ..... information screen
- (24) **STANDBY** ..... turns the CD-Recorder off
- (25) **IR sensor**

### CD-Recorder

- (2) **SOURCE** ..... selects external input source
- (3) **REC TYPE** ..... selects recording modes
- (4) **●REC** ..... starts recording, finalizing, erasing
- (5) **■ STOP** ..... stops/clears a program
- (6) **▶ PLAY/PAUSE** ..... starts play/interrupts play or recording
- (7) **ERASE** ..... selects erasing mode
- (8) **FINALIZE** ..... selects finalize mode General
- (9) **▲ OPEN/CLOSE** ..... opens/closes disc tray
- (10) **Disc tray (Deck1)** ..... records CD-R(W) and plays CD and CD-R(W)

### CD player

- (11) **Disc tray (Deck2)** ..... plays CD and CD-R(W)
- (12) **▲ OPEN/CLOSE** ..... opens/closes disc tray
- (15) **■ STOP** ..... stops/clears a program
- (16) **▶ PLAY/PAUSE** ..... starts play/interrupts play

### Note:

- When provided on the remote control, you can also use the corresponding buttons, after selecting the CD-Recorder or CD Player by pressing *CDR* (43) or *CD* (60).
- Some buttons are only on the remote control.

### Connections at the back

- (26) **ANALOG OUTPUT CD** .. connects CD player deck to the line input of an amplifier (left and right)
- (27) **ANALOG INPUT** ..... connects to the line output of an amplifier (left and right)
- (28) **ANALOG OUTPUT CDR / CD** .. connects to the line input of an amplifier (left and right)
- (29) **DIGITAL INPUT** ..... connects to the digital coaxial output of an external CD player
- (30) **DIGITAL OUTPUT CD** ... connects CD player deck to the digital coaxial input of e.g. amplifier or recording device

- (31) **OPTICAL INPUT** ..... connects to the digital optical output of an external CD player
- (32) **OPTICAL OUTPUT CD** ... connects CD player deck to the digital optical input of e.g. amplifier or recording device
- (33) **REMOTE CONTROL** ..... connects a remote control cable to the Marantz amplifier
- (34) **REMOTE CONTROL SWITCH** .. selects the remote control connections.
- (35) **AC ONTLET** ..... supplies the Power to another equipment
- (36) **AC POWER CONNECTOR** .... connect the AC cable

### DISPLAY indications

- (64) **TRK TIME/REM TRK TIME**  
**TOTL REM TIME** ..... total or remaining time of disc or track
- (65) **REM TIME/**  
**TOTL TIME** ..... remaining recording time / recording time
- (66) **STEP** ..... indicates the number of tracks in a program
- (67) **TRK** ..... track number
- (68) **□** ..... The player selected
- (69) **◀ DUBBING** ..... lights during recording from the internal CD
- (70) **||** ..... pause function active
- (71) **▶** ..... lights during play
- (72) **●** ..... lights during recording
- (73) **R (W)** ..... unfinalized CD-R(W) disc inserted
- (74) **CD** ..... CD inserted (a pre-recorded CD or finalized CD-R or CD-RW disc)
- (75) **SYNC** ..... automatic or synchronized start of external recording
- (76) **DIG** ..... digital input I selected for external recording
- (77) **MANU** ..... lights up when auto track mode is turned off
- (78) **OPT** ..... optical input I selected for external recording
- (79) **ANA** ..... analog input selected for external recording
- (80) **PROG** ..... flashes during programming/ lights in program mode
- (81) **TRK REPT** ..... lights up when a track is repeated.
- (82) **RAND** ..... plays tracks in random order
- (83) **REPT ALL** ..... lights up when a complete disc (or program) is repeated.
- (84) **SYS** ..... lights when the system connection is chosen
- (85) **L/R** ..... record/play level bar. Indicates the audio signal level.
- (86) **SCAN** ..... lights up when the first 10 seconds of each track are played.

## REMOTE CONTROL

### Remote control commands

- (37) **STANDBY**  ..... switches to Standby/On/Off
- (38) **▲ TRAY** ..... opens/closes disc tray
- (39) **DOOR** ..... opens/closes front door
- (40) **REPEAT** ..... repeat play(All, program or track)
- (41) **Number/alphabet keys 0 - 9** .. - selects a track by number  
- selects character for text input
- (42) **DISPLAY** ..... selects display information/text
- (43) **CDR** ..... selects CD-Recorder
- (44) **MENU** ..... - enters Menu mode  
- stores Menu settings
- (45) **◀◀** ..... previous track (Play and Program mode)
- (46) **◀◀** ..... - searches backward  
- cursor control in Menu/Prog. review mode
- (47) **||** ..... interrupts CD-R(W) play/recording
- (48) **■** ..... stops CD-R(W) and clears a program
- (49) **TR. INCR.**..... increases track numbers during recording
- (50) **● REC** ..... starts recording, finalizing, erasing
- (51) **SCAN** ..... plays the first 10 seconds of each track
- (52) **DIMMER** ..... Dims the brightness of the display.
- (53) **ENTER** ..... - selects settings in Menu mode  
- programs track numbers  
- starts playback of selected track
- (54) **REC TYPE** ..... selects recording modes
- (55) **SOURCE** ..... selects external input source
- (56) **▶** ..... starts CD-R(W) play
- (57) **▶▶** ..... - searches forward  
- cursor control in Menu/Prog. review mode
- (58) **CANCEL** ..... - deletes tracks from a program  
- deletes text in Menu mode  
- returns to a higher level in the menu
- (59) **▶▶|** ..... next track (Play and Program mode)
- (60) **CD** ..... selects CD player
- (61) **SCROLL** ..... activates scrolling of text over the display
- (62) **PROG.**..... opens/closes program memory
- (63) **RANDOM** ..... plays CD-R(W) or program in random order



# INSTALLATION

This CD-Recorder can be used to record directly or through a (pre-) amplifier from any digital or analog audio source.

In addition, the appliance can be used as a regular CD player. Read how to connect the CD-Recorder based on the possibilities your other audio equipment offers.

Please refer to the operating instructions for your other audio equipment first.

## The following options are available:

- analog connections
- digital coaxial connections
- digital optical connections
- remote control connections
- system connections

## Analog connections

For recording and playing, connect (using the enclosed cable with red and white plugs) the CD-Recorder to an amplifier (preferably the CD-Recorder or TAPE connection) based on the diagram below:

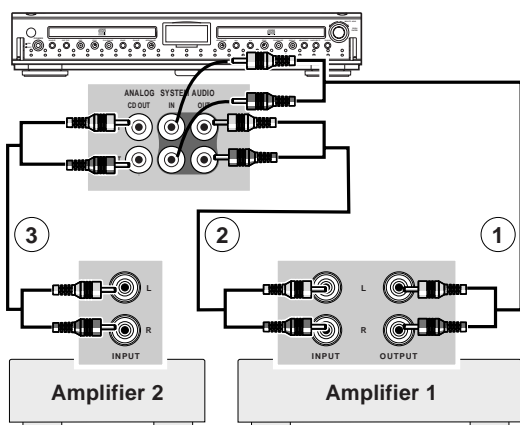

- 1 For recording, connect cable ① between the **ANALOG INPUT**-sockets on the CD-Recorder and the **CD LINE-** or **TAPE OUTPUT**-sockets of an amplifier.
- 2 For playback, connect cable ② between the **ANALOG CDR/CD OUTPUT**-sockets on the CD-Recorder and the **ANALOG INPUT**-sockets of an amplifier e.g. **TAPE IN, CD** or **AUX**.
- 3 For playback (CD Player-deck 2 only), connect cable ③ between the **ANALOG CD OUT**-sockets on the CD-Recorder and the **ANALOG INPUT**-sockets of an amplifier 2 e.g. **TAPE in, CD** or **AUX**.

### Note:

Never use the **PHONE** input.

## Digital Coaxial connections

For recording and playing, connect (using the suitable coaxial cable, available from your supplier) the CD-Recorder to a digital amplifier or other equipments based on the diagram below:

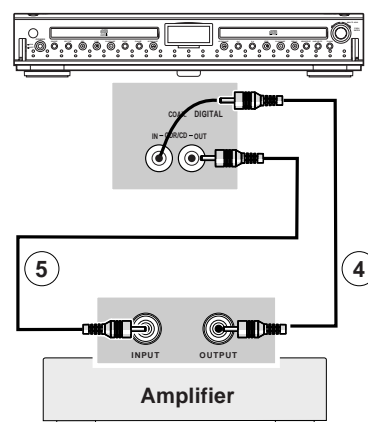

- 1 For an external recording, connect the cable ④ between the **DIGITAL INPUT**-socket on the CD-Recorder and the **DIGITAL OUTPUT**-socket of an external amplifier or CD player.
- 2 For playback, connect cable ⑤ between the **DIGITAL CDR/CD OUTPUT**-socket on the CD-Recorder and the **DIGITAL INPUT**-socket of an amplifier e.g. **CD** or **AUX**.

# INSTALLATION

## Digital Optical connections

For recording and playing, connect (using the suitable fiber-optic cable, available from your supplier) the CD-Recorder to a digital amplifier or other equipments based on the diagram below. Before connection the cables, remove the dust caps from the digital optical connections. We recommend that you save the caps.

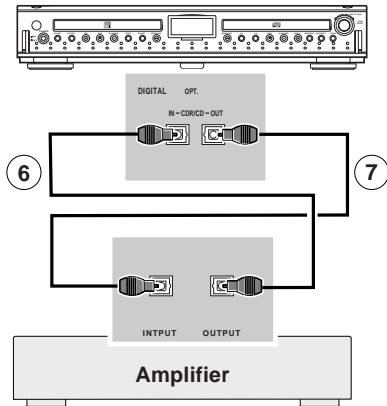

- 1 For external recording, connect a fiber-optic cable ⑥ between the **DIGITAL OPTICAL INPUT** of the CD-Recorder and the **DIGITAL OPTICAL OUTPUT** of an external amplifier or CD player.
- 2 For playback, connect cable ⑦ between the **OPTICAL CDR OUTPUT-socket** on the CD-Recorder and the **DIGITAL OPTICAL INPUT-socket** of an amplifier e.g. CD or AUX.

**Note:**

For playback, the digital coaxial outputs or analog outputs of the CD Player and CD-Recorder should be connected to an amplifier

## Remote control connections

By connecting DR2100 to the Marantz amplifier using a remote control cable ⑧, you can operate the operations of DR2100 from the remote control of the amplifier. **Set the remote control selector to 'EXTERNAL'.**

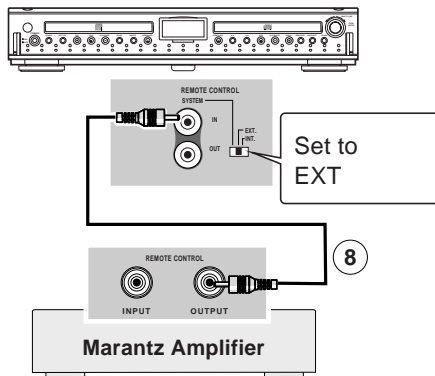

**Note:**

When you don't use the remote control connection, set the remote control selector to 'INTERNAL', to use the remote control.

## System connection

By connecting DR2100 to SR2100, you can operate this recorder by the remote control of SR2100.

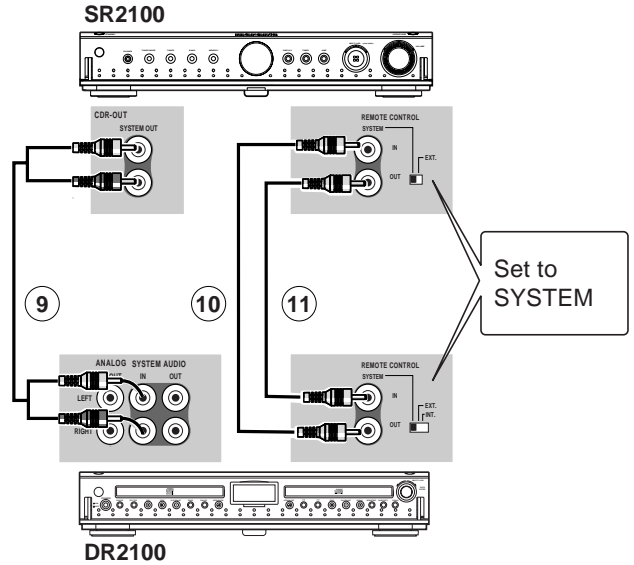

Connect the cable ⑨ for audio signal and ⑩ and ⑪ for system signal. Set the remote control selector to "SYSTEM" for both DR2100 and SR 2100.

Set the power ON/OFF switch to "ON" for DR2100.

More Information, please refer the SR2100 users manual

**Note:**

When you don't use the system connection, set the remote control selector to 'INTERNAL' to use the remote control.

# USING THE RECORDER

The numbers between parentheses refer to the fold-out.

## Switching ON and OFF

- 1 Connect the power cord into the mains.

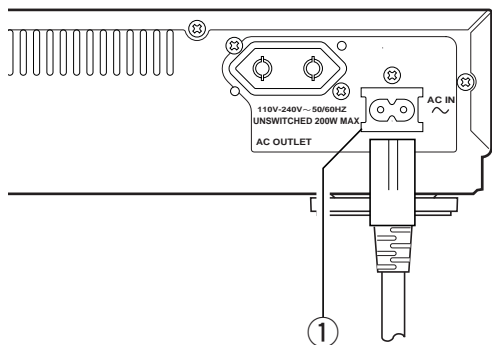

- 2 Press the **POWER ON/OFF** (1) button on the front of the CD-Recorder to turn it on or off.

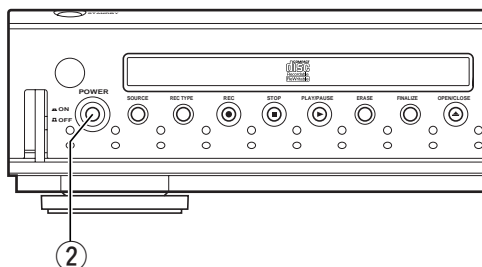

## Using the remote control

- 1 Open the battery compartment cover.
- 2 Insert 2 batteries (AA, LR-6 or UM-3; as supplied) as shown.
- 3 Replace the cover.

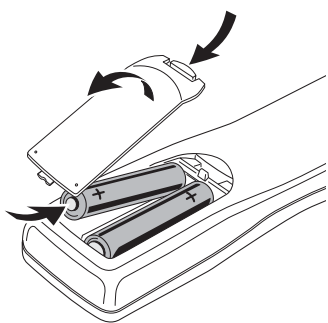

**Note:**

- We recommend you use **2 batteries of the same type and condition.**
- When operating the remote control, point it at the remote sensor located on the CD-Recorder's front panel. The remote control can be used up to 17 feet (5m) from the CD-Recorder and within a 30° angle on each side of the sensor.

This remote control can switch "STANDBY ON/OFF" but cannot switch "POWER ON/OFF" the CD-Recorder.

**Batteries contain chemical substances, so they should be disposed of properly.**

## Inserting discs

- 1 Press **OPEN/CLOSE** (22, 39) to open the Front door.
  - If the **POWER** (1) is not turned on yet, manually open the front door and turn on the power.

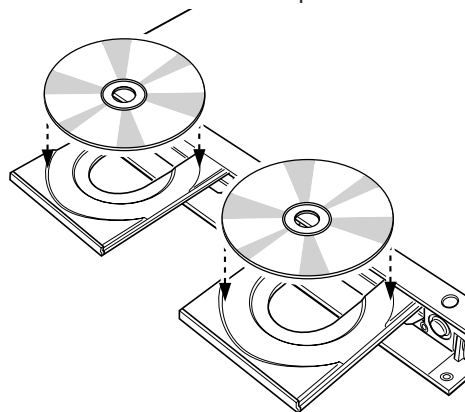

- 2 Press **▲ OPEN/CLOSE** (10, 11, 38) to open the disc tray.
  - **OPEN** lights up.
  - On the remote control, you can choose the deck pressing by **CDR** (43) or **CD** (60).

**Note:**  
When you press the **▲ OPEN/CLOSE** (10,11), the tray might hit your finger.

- 3 Insert a CD, CD-R or CD-RW in the appropriate recess in the tray, label side up.
- 4 Press **▲ OPEN/CLOSE** (10, 11, 38) to close the tray.
  - **CLOSE** lights up, followed by **READING** and the display will show the type of disc you inserted.



- If a CD-R(W) is finalized it will show CD on the display.
- If CD-text is available the TITLE/ARTIST will scroll by.

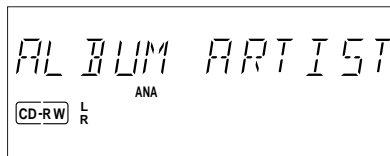

**Note:**

**Only Audio CDs will be accepted.** If a non-audio disc is inserted, the display shows **WRONG DISC**.

### CD-Recorder deck only

- For recording it is important that the blank disc is completely free from dust particles or scratches. (see Compact Discs page 1).
- If you insert a blank or partly-recorded CD-R or unfinalized CD-RW, the CD-Recorder will calibrate the disc for optimum recording. During this process the display will first show **INITIALISING** and then the number of audio tracks. Calibration can take up to 25 seconds.



# RECORDING

The numbers between parentheses refer to the fold-out.

## Remarks about recording

You will soon discover how easy it is to make your own CDs. Nevertheless, it is advisable to use a CD-RW disc for your first try. We will describe:

- Digital recording (fast or normal recording).
- Recording from external CD player:
  - Digital
  - Digital (synchronized start with external CD player)
  - Analog
- **If the disc is a CD-RW and is already finalized you must unfinalize it first.**
- The recording procedure is the same for CD-Rs and CD-RWs.
- If the disc already contains recordings, the CD-Recorder will automatically search for the end of the last track, so that recording can start from there.
- **There must be at least 7 seconds of recording time left on the disc**, otherwise you will not be able to enter record standby mode. *DOES NOT FIT* then lights up.
- If the display indicates *COPY PROTECT*, no digital recording can be made of the source material. Recording will not start.
- **The Serial Copy Management System (SCMS) only allows digital recording under specific conditions:**
  - This means that it is not possible to make a digital copy from a digital copy.
  - Analog recording is always possible !
  - The number of recordings from the original is unlimited.

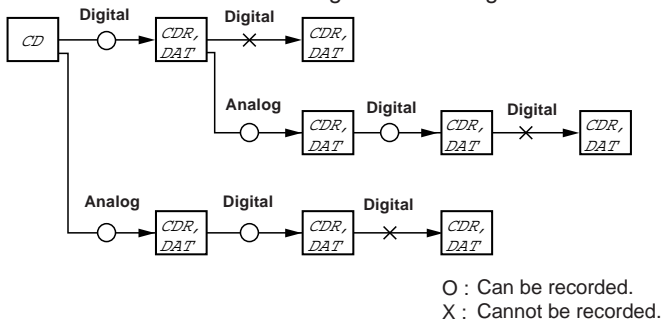

- A maximum of 99 tracks can be recorded on a disc. Minimum allowable track length is 4 seconds.
- Recordings from DAT or DCC players will not always stop automatically.

### Important:

If you want to play the recorded CD-R disc on any regular CD player, it must first be finalized. (See FINALIZING/UNFINALIZING page 14.)

Finalized CD-RW discs play only on CD-RW compatible CD players.

The CD-Recorder records the text memory simultaneously when using the internal CD-deck. Some discs are prohibited to copy the text memory. If such a disc is copied, no text memory will be recorded.

## Recording modes

Your recorder offers several recording modes.

### For recording from internal CD-deck:

- *RECORD FAST* (double speed recording) - fast recording of a disc or programmed tracks.
- *REC LISTEN* (normal speed recording) - listening to a recording while making it.
- *MAKE CD* (double speed recording and auto-finalize) - fast recording of a disc or programmed tracks. Recording will be finalized automatically.

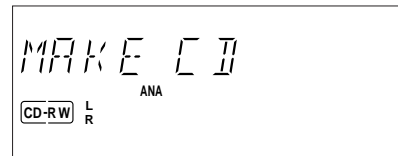

### Warning:

No more recording possible after finalizing CDR disc!

### For recording from external sources:

- *REC EXT DISC* (CD-SYNC recording) - to make an automatic recording of an external source simply by starting the source.
- *REC EXT MAN* (manual start recording) - to start a manual recording from an external source.

### Some remarks on recording:

- During double speed recording, the original recording quality will be maintained.
- When **Auto track is on** (default setting), **track numbers will automatically be increased during recording.**
- By programming tracks first, a compilation can be recorded.
- If a finalized CD rewritable disc is inserted in the CD-Recorder, *UNFINALIZE* and *PRESS ENTER* will be displayed when the *REC TYPE* (3) is pressed. If *PUSH ENTER* (21) is pressed, the disc will be unfinalized.
- When you copy a special disc such as HDCD or DTS, you have to
  - set the sampling frequency at 44.1kHz.
  - use the digital connection.
  - set the digital rec-volume of the CD-Recorder at 0 dB.
- When you copy the tracks from a DAT recorded by different sampling frequencies, noise might be recorded in the disc. Please set a sampling frequency for every track in a DAT.
- This CD-Recorder can record about 17 seconds of a pause time, which decreases the time count just before music start in a track on the display. If you record a track including more than 17-seconds-pause time by digital recording, the pause time will be recorded the different length of time from original. However, the entire track time will not be changed and be able to listen to the music as same as original.

### Note:

If during recording *ANALOG REC* appears, the track will be recorded as analog, at normal speed. All other tracks will be copied normally (at double speed).

# RECORDING (FROM INTERNAL CD-DECK)

The numbers between parentheses refer to the fold-out.

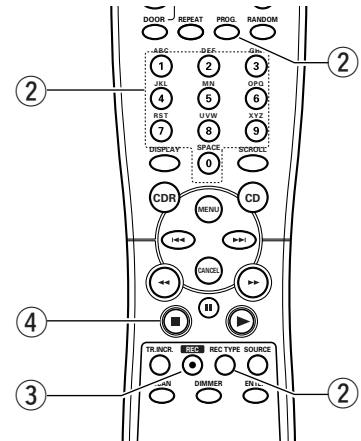
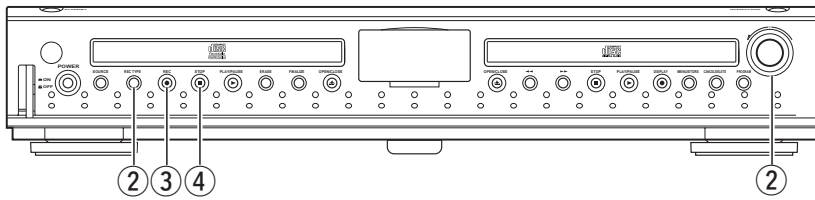

## Double speed recording

Using internal CD player.

- During double speed recording the sound is not audible.

① **Make sure that the recording disc is absolutely free of scratches and dust particles.**

② **To choose the type of recording, press *REC TYPE* (3, 54).**  
**once:** to select *RECORD FAST* if you wish to make a fast recording of a disc or programmed tracks.  
**three times:** to select *MAKE CD* if you wish to make a fast recording of a disc or programmed tracks and to automatically finalize the recording. Also see 'FINALIZING CD-R & CD-RW' discs on page 14.

The **DUBBING** label starts blinking. After 3 seconds the display shows the remaining CD-R(W) recording time on the left and total time of source on the right. (every 2 seconds *PRESS RECORD* is displayed.) Both selection indicators are lit.



- Press **PROGRAM** (20, 62) to select one or more tracks for recording (see **PROGRAMMING** page 18):
  - rotate the **MULTI JOG** (21) key to the required track number, then press **PUSH ENTER** (21).
- or:
  - directly select the track number via the **10-keypad** (41) on the remote control, then press **ENTER** (53).

③ **To start recording press ● *REC* (4, 50).**

→ The display shows the real remaining time for the selected recording. High speed recording starts.

◀ **DUBBING** lights continuously.

- To check the elapsed recording time, press **DISPLAY** (17, 42). This can be done during recording.
- Recording will stop automatically.

**Note:**

Copy prohibited tracks will be copied analog. *ANALOG REC* is displayed.

④ **To stop recording manually, press ■ *STOP* (5, 48).**

→ ◀ **DUBBING** goes out and recording stops.

- If **STOP** (5, 48) was pressed within 3 seconds after **REC** (4, 50), no recording will take place.
- After recording, the display shows *UPDATE* for several seconds. The Total time indications can differ slightly. However, no music information is lost.

**Note:**

- In this Recording mode, the Pause function is not operative.

**Important:**

- If you want to play the recorded CD-R(W) disc on any regular CD player, it must first be finalized. (See **FINALIZING/UNFINALIZNG** page 14).
- Sound might be distorted when the recording levels are set more than 0 dB for digital and -12dB for analog recording.
- The factory settings are 0 dB for digital and -12dB for analog recording.
- The rec level will remain for next time. Please check the rec level before start recording.
- Finalized CD-RW discs play only on CD-RW compatible CD players.

# RECORDING (FROM INTERNAL CD-DECK)

The numbers between parentheses refer to the fold-out.

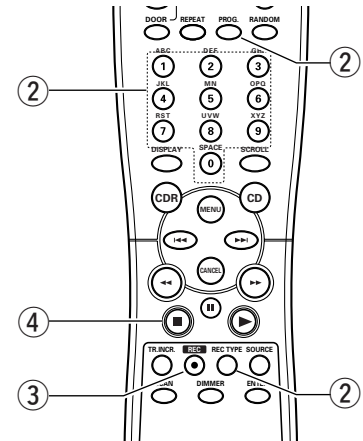
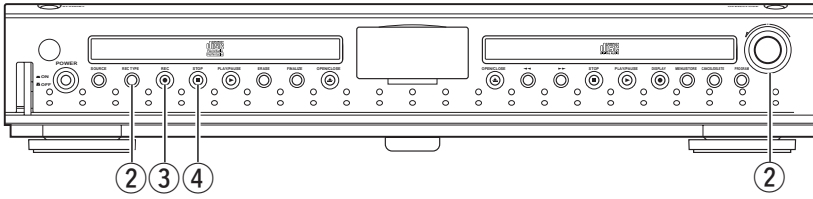

## Normal speed recording

Using the internal CD player.

During the normal speed recording, you can listen to the recording while you are making it.

① **Make sure that the recording disc is absolutely free of scratches and dust particles.**

② **For recording, press *REC TYPE* (3, 54) twice.**

- The ◀ **DUBBING** label starts blinking. After 3 seconds the display shows the remaining CD-R(W) recording time on the left and total time of source on the right. (every 2 seconds *PRESS RECORD* is displayed) Both selection indicators are lit.



- Press *PROGRAM* (20, 62) to select one or more tracks for recording (see *PROGRAMMING* page 18):
  - rotate the *MULTI JOG* (21) key to the required track number, then press *PUSH ENTER* (21).

or:

- directly select the track number via the *10-key pad* (41) on the remote control, then press *ENTER* (53).

③ **To start recording, press ● *REC* (4, 50).**

- ◀ **DUBBING** lights continuously and the selected track or program is copied at normal speed. The recording time left will appear.

- To check the elapsed recording time, press *DISPLAY* (17, 42). This can be done during recording.
- Recording will stop automatically.

### Note:

Copy prohibited tracks will be copied analog. *ANALOG REC* is displayed.

④ **To stop recording, press ■ *STOP* (5, 48).**

- ◀ **DUBBING** goes out and recording stops.

- If ■ *STOP* (5, 48) was pressed within 3 seconds after ● *REC* (4, 50), no recording will take place.
- After recording, the display shows *UPDATE* for several seconds. The Total time indications can differ slightly. However, no music information is lost.

### Note:

In this recording mode, the Pause function is not operative.

### Important:

- If you want to play the recorded CDR disc on any regular CD player, it must first be finalized. (See *FINALIZING/UNFINALIZING* page 14.)
- Sound might be distorted when the recording levels are set more than 0 dB for digital and -12dB for analog recording.
- The factory settings are 0 dB for digital and -12dB for analog recording.
- The rec level will remain for next time. Please check the rec level before start recording.
- Finalized CD-RW discs play only on CD-RW compatible CD players.
- If a track is protected by SCMS, the track will be recorded by analog.

# RECORDING (FROM EXTERNAL SOURCE)

The numbers between parentheses refer to the fold-out.

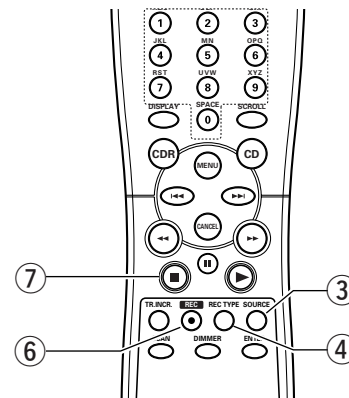
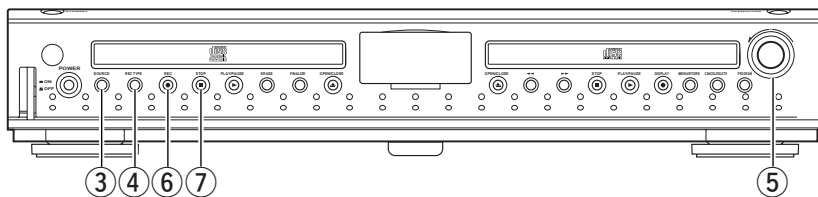

## Manual start recording

Manual recording from external CD player.

- ① Make sure the disc is absolutely free of scratches and dust particles.
- ② Connect the cable from an external CD player to the CD-Recorder. (see INSTALLATION page 5 and 6.)
- ③ Press **SOURCE** (2, 55) repeatedly until the selected external source appears on the display (depending on the connection used):  
→ **DIG**, **OPT** or **ANA** lights up and **DIGITAL**, **OPTICAL** or **ANALOG** appears on the display.



### About Auto Track increment

- When Auto Track is ON (default setting), track numbers will automatically be increased during recording.
  - To switch off the Auto Track function you have to enter MENU MODE.  
If you wish to increase track numbers manually, press TRACK INCR(ement) on the remote control. For further instructions see MENU MODE.
- ON (AUTO):** The track increments are automatically taken over from the digital source material or after 2.7 seconds silence during analog recording.
- OFF (MANUAL):** Track numbers can be incremented manually by pressing **TRACK INCR** (49) (ement) on the remote control. (Minimum track length is 4 sec.)
- Track numbers cannot be changed after recording.

### Note:

Auto track works only with Consumer Sources with a digital output signal according to the IEC 958 (consumer part) audio standard.

- ④ With the recorder stopped, press **REC TYPE** (3, 54) five times to enter the Manual Record standby mode.  
→ The display shows **REC EXT MAN**.

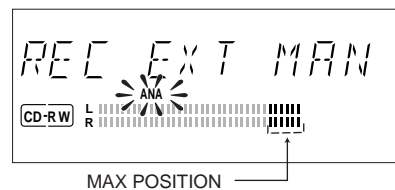

- If **CHECK INPUT** message also flashes, the digital connection is incorrect.
- ⑤ Set the optimal recording level on the CD-Recorder.
    - ① Play the source first to set the optimal recording level on the CD-Recorder.
    - ② Rotate the **MULTI JOG** (21) to adjust the recording level. The maximum position of the level could be reaching the dotted line on the picture once in the while.  
DIGITAL RECORDING : +6dB ~ -63dB  
ANALOG RECORDING : 0dB ~ -63dB
    - ③ Stop the source.
  - ⑥ To start recording, press ● **REC** (4, 50) on the CD-Recorder and immediately start the source (from Stop-mode).  
The track number and recording time left appear on the display.
    - To record a 3-second silence at the start of a track, press ►/|| **PLAY/PAUSE** (6, 47) on the CD-Recorder before starting the source.
    - To check the elapsed recording time, press **DISPLAY** (17, 42) on the CD-Recorder.
  - ⑦ To stop recording, press ■ **STOP** (5, 48) on the CD-Recorder.
    - If ■ **STOP** (5, 48) was pressed within 3 seconds after ● **REC** (4, 50), no recording will take place.
    - To interrupt recording, press ►/|| **PLAY/PAUSE** (6, 48) on the CD-Recorder. Press ● **REC** (4, 50) to resume.

After recording the display will show **UPDATE** for several seconds.

### Important:

- If you want to play the recorded CDR disc on any regular CD player, it must first be finalized. (See FINALIZING/UNFINALIZING page 14.)
- Sound might be distorted when the recording levels are set more than 0 dB for digital and -12dB for analog recording.
- The factory settings are 0 dB for digital and -12dB for analog recording.
- The rec level will remain for next time. Please check the rec level before start recording.
- Finalized CD-RW discs play only on CD-RW compatible CD players.

# RECORDING (FROM EXTERNAL SOURCE)

The numbers between parentheses refer to the fold-out.

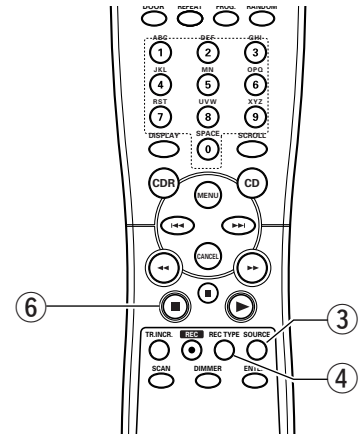
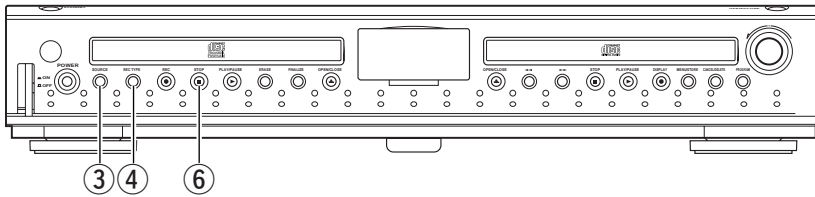

## CD-SYNC

Autostart recording from external CD player CD-SYNC.

The CD-SYNC feature enables you to make fast and easy recordings of a CD. Track increments are automatically detected from the source material. Track increments cannot be added manually. In analog source material a silence of 2.7 seconds or more is automatically detected as a track increment.

- ① **Make sure the disc is absolutely free of scratches and dust particles.**
- ② **Connect the cable from an external CD player to the CD-Recorder.** (see INSTALLATION page 5 and 6.)
- ③ **Press SOURCE (2, 55) repeatedly until the selected source, appears on the display** (depending on the digital connection used):  
→ **DIG**, **OPT** or **ANA** lights up and **DIGITAL**, **OPTICAL** or **ANALOG** appears on the display.



- ④ **With the CD-Recorder stopped, press REC TYPE (3, 54) four times: if you wish to record a complete disc or program.**  
→ **SYNC** start to flash and the display shows **REC EXT DISC**.



- If **CHECK INPUT** message also flashes, the digital connection is incorrect.
- ⑤ **To start recording, press PLAY on the selected source.**  
→ The CD-Recorder automatically starts to record. The recording time left appears on the display.
- If **DIG**, or **OPT** blinks, the digital connection is incorrect.
  - If, however, you start the source during a track, CD-SYNC recording starts at the beginning of the next track or after 2.7 seconds of silence in analog recordings.

- To check the elapsed recording time, press **DISPLAY** (17, 42). (This can also be done during recording)
- The recorder stops automatically.

- ⑥ **To stop recording manually, press ■ STOP (5,48) on the CD-Recorder.**

- If ■ **STOP** (5, 48) was pressed within 3 seconds after pressing **PLAY** on the selected source, no recording will take place.
- To interrupt recording, press ►/|| **PLAY/PAUSE** (4, 48) on the CD-Recorder.  
To resume, press ● **REC** (4, 50) on the CD-Recorder.

After recording the display will show **UPDATE** for several seconds.

### Note:

- Recordings from DAT, DCC or analog sources will only stop after 20 seconds silence.
- With **AUTO TRACK ON**, recordings from DAT, DCC or recordings made analogously will stop after 20 seconds silence. With **AUTO TRACK OFF**, the auto stop mode is disabled.

### Important:

- If you want to play the recorded CD-R disc on any regular CD player, it must first be finalized. See **FINALIZING/UNFINALIZING** page 14.
- Sound might be distorted when the recording levels are set more than 0 dB for digital and -12dB for analog recording.
- The factory settings are 0 dB for digital and -12dB for analog recording.
- The rec level will remain for next time.  
Please check the rec level before start recording.
- Finalized CD-RW discs play only on CD-RW compatible CD players.



# SYSTEM RECORDING (FROM EXTERNAL SOURCE)

The numbers between parentheses refer to the fold-out.

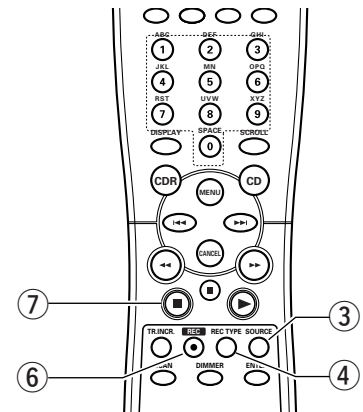
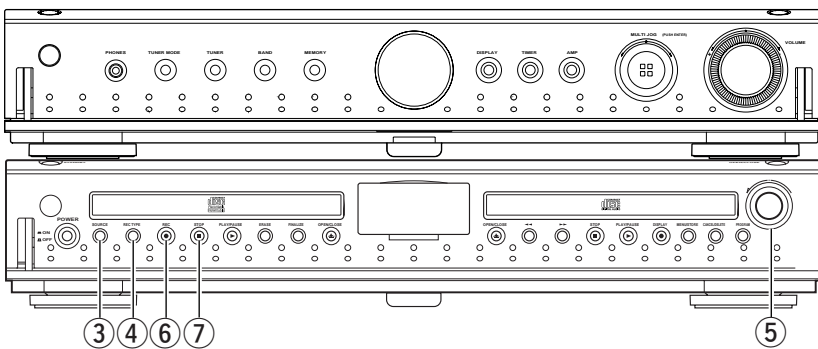

## System connection recording

DR2100 is also able to make the external recording by combination of Marantz products such as SR2100 or DV2100 using system connection.

- ① Make sure the disc is absolutely free of scratches and dust particles.
- ② Connect the cables as the system connection (See page 6)
  - Set the remote control selector to SYSTEM for both DR2100 and SR2100
- ③ Press **SOURCE** (2, 55) repeatedly until **ANA** appears on the display
- ④ When the recorder stopped, press **REC TYPE** (3, 54) five times to enter the Manual Record standby mode.
  - the display shows *REC EXT MAN.*

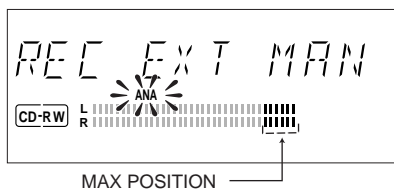

- ⑤ Set the optimal recording level on the CD-Recorder.
  - ① Play the source first to set the optimal recording level on the CD-Recorder.
  - ② Rotate the **MULTI JOG** (21) to adjust the recording level. The maximum position of the level could be reaching the dotted line on the picture once in the while.
- ⑥ To start recording, press ● **REC** (4, 50) on the CD-Recorder and immediately start the source (from the Stop-mode).
 

The track number and recording time left appear on the display.

  - To record a 3-second silence at the start of a track, press ►/|| **PLAY/PAUSE** (6, 47) on the CD-Recorder before starting the source.
  - To check the elapsed recording time, press **DISPLAY** (17, 42) on the CD-Recorder.
- ⑦ To stop recording, press ■ **STOP** (5, 48) on the CD-Recorder.
  - If ■ **STOP** (5, 48) was pressed within 3 seconds after ● **REC** (4, 50), no recording will take place.

- To interrupt recording, press ►/|| **PLAY/PAUSE** (6, 48) on the CD-Recorder. Press ● **REC** (4, 50) to resume.

After recording the display will show *UPDATE* for several seconds.

### NOTE:

- Connecting to SR2100 by system connection, you can operate this recorder from the SR2100 remote controller.
- You can listen to the other sound from the other source, for example, radio on the SR2100 or DVD on the DV2100 during the internal recording on the DR2100.

### Important:

- If you want to play the recorded CDR disc on any regular CD player, it must first be finalized. (See FINALIZING/UNFINALIZING page 14.)
- Sound might be distorted when the recording levels are set more than 0 dB for digital and -12dB for analog recording.
- The factory settings are 0 dB for digital and -12dB for analog recording.
- The rec level will remain for next time. Please check the rec level before start recording.
- Finalized CD-RW discs play only on CD-RW compatible CD players.

# FINALIZING/UNFINALIZING

The numbers between parentheses refer to the fold-out.

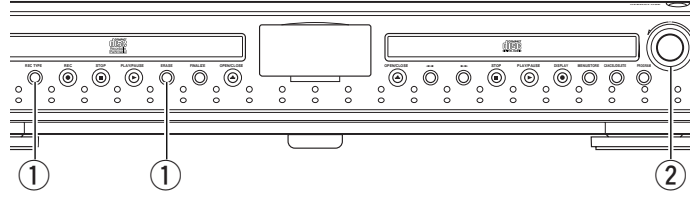
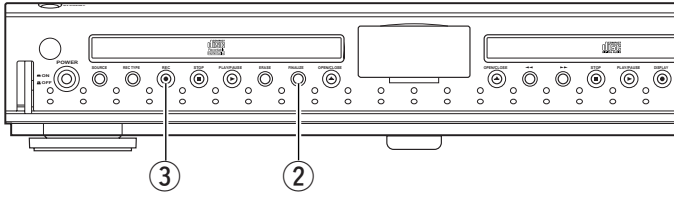

## Finalizing CD-R & CD-RW discs

Finalizing is a simple procedure, necessary to:

- be able to play the recorded CD-R(W) disc on a CD PLAYER.
- avoid further unwanted recordings on a disc.
- avoid erasure of tracks on a CD-RW.

### Auto finalizing

Auto finalizing is possible when using the **MAKE [ ]** recording function.

### Manual finalizing

- ① Make sure the disc (in the CD-Recorder) is absolutely free of scratches and dust particles.
- ② With the recorder stopped press **FINALIZE (8)**.  
→ The display shows **FINALIZE** and **PRESS RECORD**.



- ③ Press ● **REC (4)**.

- **XXXX FINAL** and the approximate finalization time appears on the display.
- The display counts down through the finalization.
- On completion, the total number of tracks and the total time recorded appears on the display.
- For CD-R(W), changes to CD on display.

Finalizing will take at least 2 - 4 minutes.

### Note:

During finalization, the CD-Recorder accepts no operating commands.

## Unfinalizing CD-RW discs

For CD-RW discs only.

If you want to make more recordings (or erasures of tracks) on a finalized disc you must unfinalize it first. The Table of Contents (TOC) will be removed.

- ① With the CD-Recorder stopped, press **REC TYPE (3)** or **ERASE (7)**.  
→ **UNFINALIZE** and **PRESS ENTER** will appear on the display.

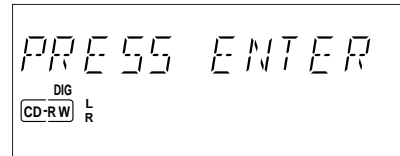
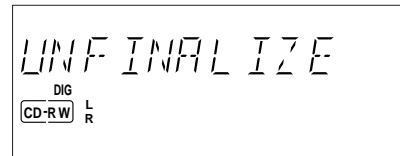

- ② Press **PUSH ENTER (21)**.

- The disc will now be unfinalized and can be recorded on again.



### Note:

- Unfinalizing will take approximately 1.5 minutes.
- When unfinalizing a CD-RW disc with text on it available, this text will be transferred to the CD-Recorder memory. It may occur that the text memory is full. The message **MEMORY FULL/FINALIZE [ ]** will be displayed. You will now have to erase text, stored for other discs, or finalize another disc in order to obtain memory space.

# ERASING

The numbers between parentheses refer to the fold-out.

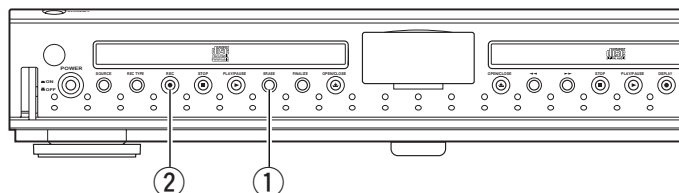
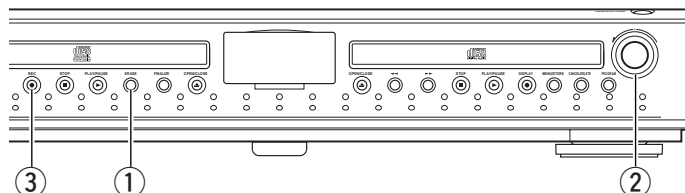

## Erasing

For unfinalized CD-RW discs only.

You can erase:

- one or more tracks from the end,
- the entire disc.

## Erasing one or more tracks from the end

### ① Press **ERASE (7)** once.

→ The display shows the number of tracks and their total playing time. *ERASE TRACK* and *PRESS RECORD* lights up.

- If the disc is finalized, CD appears on the display after inserting a CD-RW in the recorder. The recorder will ask you to confirm unfinalizing first. Confirm by pressing the *PUSH ENTER (21)* key.

### ② Select the track(s) you wish to erase by turning the **MULTI JOG (21)** key to the left and confirm by pressing this key.

→ The display shows the remaining number of tracks and the remaining playing time after erasing the selected track(s).

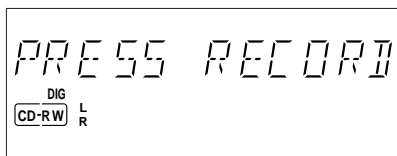
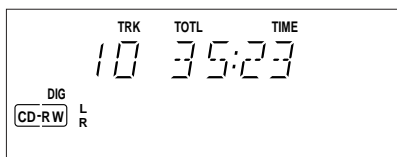

## Erasing the entire disc

### ① Press **ERASE (7)** twice.

→ The display shows the number of tracks and their total playing time. *ERASE DISC* and *PRESS RECORD* light up.

- If the disc is finalized, CD appears on the display after inserting a CD-RW in the recorder. The recorder will ask you to confirm unfinalizing first. Confirm by pressing the *PUSH ENTER (21)* key.

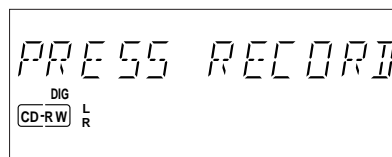
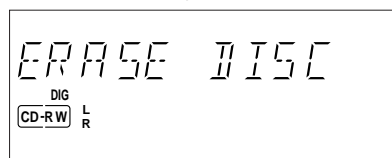

### ② Press **REC (4)**.

→ The display shows the total countdown time and *ERASE* appears on the display. The complete disc will be erased.

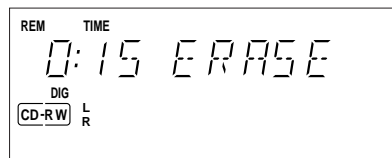

Erasure of a complete disc may take up to 15 seconds.

### ③ Press **REC (4)**.

→ The display shows the total countdown time and *ERASE* appears on the display.

→ After the selected track(s) have erased, the display shows the remaining tracks and their total playing time.

# PLAYING

The numbers between parentheses refer to the fold-out.

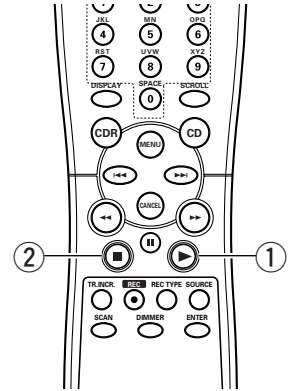
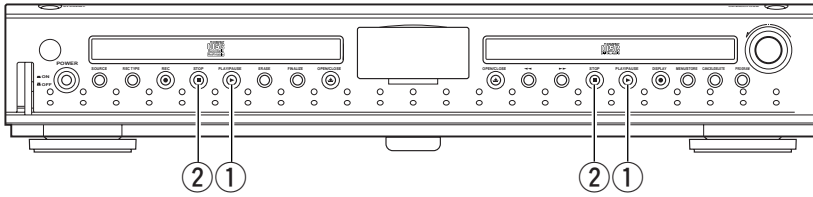

## Playing a 2-disc-changer

Your CD-Recorder is able to play the two decks sequentially.

**① On the deck you want to play, press ►|| PLAY/PAUSE (6, 16, 56) to start CD play.**

- The track number and track time of the track in play appear on the display.
- The second disk will not be played back until the first disk has finished no matter whether playback is run from deck one or deck two. The playback procedure will be automatically ended once playback of the second disk has been completed.

- Press *DISPLAY* (17, 42) once, twice or three times to see:
  - remaining track time, total remaining time, text information (see MENU MODE page 19).
- To interrupt play temporarily, press ►|| *PLAY/PAUSE* (6, 16, 47) again.
  - || lights on the display.
- To continue play, press ►|| *PLAY/PAUSE* (6, 16, 47) again.

**② To stop play, press ■ STOP (5, 15, 48).**

- The number of tracks and the total playing time appear on the display.

# PLAYING

The numbers between parentheses refer to the fold-out.

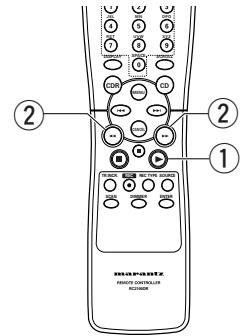
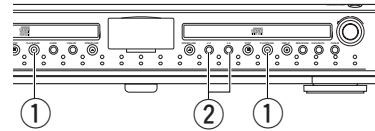
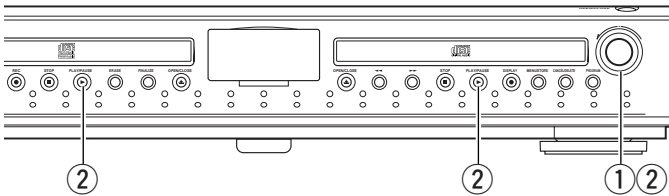

## Selecting a track

### Selecting a track during play

- ① On the DR2100 recorder.  
Turn the **MULTI JOG (21)** key until the required track number appears on the display.  
→ Play skips to the beginning of the selected track.
- ② On the remote control <i>. Select **CDR (43)** or **CD (60)** and key in the required track number using the **NUMERICAL (41)** keys. For 2-digit track numbers, press the keys in rapid succession. For tracks on the other disc, first press **CD (60)** or **CDR (43)** as applicable.  
→ Play skips to the beginning of the selected track.
- ③ On the remote control <ii>.  
Press **◀◀ (45)** or **▶▶ (59)** one or more times.  
→ Play skips to the beginning of the previous or subsequent tracks, including tracks on other disc.

### Selecting a track when CD play is stopped

- ① On the DR2100 recorder.
  - ① Turn the **MULTI JOG (21)** key until the required track number appears on the display.
  - ② Press **PUSH ENTER (21)** to confirm or press **▶/|| PLAY/PAUSE (6, 16)** to start playing.
- ② On the remote control <i>.
  - ① Select **CDR (43)** or **CD (60)** and key in the required track number using the **NUMERICAL (41)** keys. For 2-digit track numbers, press the keys in rapid succession. Play starts.
- ③ On the remote control <ii>.
  - ① Briefly press **◀◀ (45)** or **▶▶ (59)** one or more times.
  - ② Start playback by pressing **▶ (56)** or **ENTER (53)**.

## Scan play

- ① To start scan play, press **SCAN (51)** on the remote control.
  - It plays the first 10 seconds of each track.
  - It automatically stops after playing all tracks.
- ② To stop playing, press **■ (48)**.
  - The SCAN label disappears from the display.

## Search

- ① Press **▶/|| PLAY/PAUSE (6, 16, 56)**.
- ② Hold down **◀◀ (13, 46)** or **▶▶ (14, 57)**.
  - The player first searches backwards or forwards at 10 times normal speed with sound at low volume, then goes to 50 times normal speed with sound muted.
- ③ Release the button at the desired passage.
  - Play starts at the desired passage.

### Note:

During Random, Repeat Track or Programmed play, search is restricted to within the track being played at the time.

## Random play

- ① Press **RANDOM (63)** before or during CD play to start play.
  - The tracks on the CD (or program if set) play in random order.
- ② Press **RANDOM (63)** again to stop play.

### Note:

- RANDOM is also cleared if you open the disc tray.
- RANDOM (63) button is only on the remote control.

## Repeat play

- ① Press **REPEAT (40)** one or more times during CD play.
  - When **TRK REPT** lights up, the current track plays repeatedly. When **REPT ALL** lights up, the all tracks or programmed tracks play repeatedly.

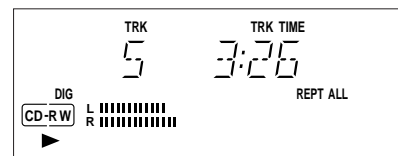

- ② To return to normal play, press **REPEAT (40)** one or more times until:
  - The REPT label disappears from the display.

### Note:

- Repeat is also cleared if you open the disc tray.
- REPEAT (40) button is only on the remote control.

# PROGRAMMING

The numbers between parentheses refer to the fold-out.

## Programmed play

- You can program up to 99 tracks to play in any desired sequence.
- Tracks can be programmed more than once.
- A program for playback can be made from both the disc in the recorder and the disc in the player. A program for recording can only be made from the disc in the player (CD deck).

## Programming for playback

- 1 Press **PROGRAM** (20,62) to enter Program mode.  
→ **PROG** flashes and **PROGRAM** appears on the display.



- 2 Select the required track numbers by turning the **MULTI JOG** (21) key left or right and store by pressing **PUSH ENTER** (21).

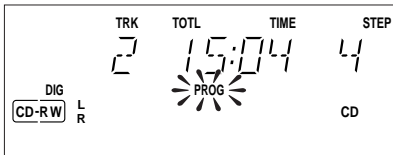

or:

**Key in a track number with the NUMBER** (41). For 2-digit numbers, press the keys in rapid succession.

- The track will be stored in the program.
- The track number and total program time are displayed.

- 3 Repeat step ① to ② for all tracks to be programmed.
- 4 Press **STOP** (5, 48) or **PROGRAM** (20, 62) on the remote control to end programming.  
→ **PROG** lights continuously.
- 5 Press **PLAY/PAUSE** (6, 56) to start programmed play.

## Programming for recording

- 1 Press **REC TYPE** (3, 54) to select the required recording mode (see 'RECORDING').
- 2 Compile your program as described in "programming for playback".
  - Only tracks from the disc in the CD player can be stored.
- 3 Press **REC** (4, 50) to start recording.

### Note:

- To review the program, press **PROGRAM** (20, 62), followed by **◀◀** (13, 46) or **▶▶** (14, 57) with the CD player or CD-Recorder in stop mode.
- To add more tracks to the program, repeat steps ① to ③.
- If you try to store more than 99 tracks, **PROG FULL** appears on the display.

## Clearing a program

- 1 Press **STOP** (5, 15, 48) if necessary to stop programmed play.
  - 2 Press **STOP** (5, 15, 48) again to clear the program.  
→ **PROG** disappears from the display.
- The program is also cleared if you open the disc tray.

## Erasing a track from a program

- 1 In Stop mode press **PROGRAM** (20, 62) on the remote control to enter Program mode.
- 2 Use **◀◀** (13, 46) or **▶▶** (14, 57) to select the track from which to delete.  
→ The track number and program step will be shown on the display.
- 3 Press **CANCEL/DELETE** (19, 58) to erase the track from the program.  
→ The remaining program steps and the playing time of the program will be displayed.

# MENU MODE

The numbers between parentheses refer to the fold-out.

EX: Storing names of Text settings

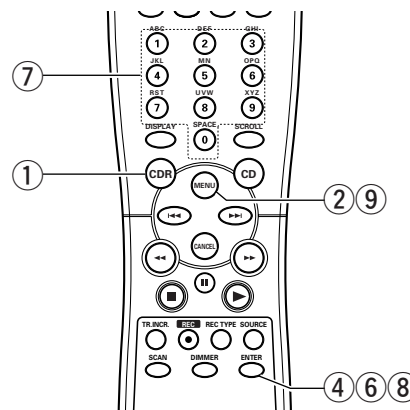
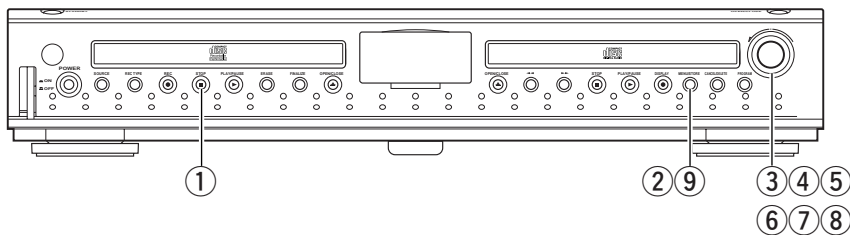

## MENU MODE can set up:

- **Text setting** ..... adding erasing the CD text
- **Recording setting** ..... Auto track increment ON/OFF and adjustment of the right-left-volume balance adjustment during the recording
- All settings (except Balance) made in Menu mode will be stored in the deck's memory and can be called up and changed at any time.

### Note:

Text can only be edited for unfinalized discs. (finalized CD-RW discs must be unfinalized first)

## Text settings

The TEXT submenus allows you to enter text information on the CD-R(W); for example the CD titles, the artist names, the track names and so on. During the playback, the TEXT will be appeared on the display.

### Storing names

- 1 Press **STOP (5)** of the CDR deck or **CDR (43)**.
- 2 Press **MENU/STORE (18, 44)** to enter Menu mode. TEXT EDIT appears on the display.
- 3 Rotate **MULTI JOG (21)** to select the *TEXT EDIT* submenus.
- 4 Press **PUSH ENTER (21)** or **ENTER (53)** on the remote control to confirm.
- 5 Rotate **MULTI JOG (21)** to select the required option in the submenu: CD Artist, CD Title, Track 1 Artist, Track 1 Title, etc.
- 6 Press **PUSH ENTER (21)** or **ENTER (53)** on the remote control to confirm.
- 7 Select the characters by rotating the **MULTI JOG (21)** or by pressing the corresponding numeric/alphabet key on the remote control.

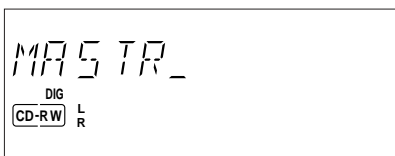

### Note:

- A maximum of 60 characters can be stored per item.
- With the **◀◀ (13, 46)** **▶▶ (14, 57)** keys you can move to a required cursor position.
- With the **CANCEL/DELETE (19, 58)** you can delete a character.

8 Press **PUSH ENTER (21)** or **ENTER (53)** on the remote control to store the characters and move to the next cursor position.

9 Press **MENU/STORE (18, 44)** to store a name you have entered and return to the submenu or **STOP (5, 48)** to exit.

### Note:

- By pressing the **PUSH ENTER (21)** or **ENTER (53)** on the remote control without selecting a character first, you can insert a space between characters.
- When an artist's name has been stored for a certain track, the name will automatically be copied for the next track. The name can be confirmed by pressing **MENU/STORE (18, 44)** or a new name can be entered as described above.

### Erasing names

- 1 Press **STOP (5)** of the CDR deck or **CDR (43)**.
- 2 Press **MENU/STORE (18, 44)** on the deck or the remote control to enter Menu mode.
- 3 Rotate **MULTI JOG (21)** to select the submenu **TEXT ERASE**. *TEXT ERASE* appears on the display.
- 4 Press **PUSH ENTER (21)** or **ENTER (53)** on the remote control to confirm.
- 5 Rotate **MULTI JOG (21)** to select the required option in the submenu: All Text, CD Title, CD Artist, Track 1 Title, Track 1 Artist, etc.
- 6 Press **PUSH ENTER (21)** or **ENTER (53)** on the remote control to confirm. The display will ask you to reconfirm your selection.
- 7 Press **PUSH ENTER (21)** or **ENTER (53)** on the remote control to reconfirm.
- 8 Press **MENU/STORE (18, 44)** to return to the submenu or **STOP (5, 48)** to exit.

# MENU MODE

The numbers between parentheses refer to the fold-out.

## Text Memory Review/Erase Text Memory

The input text data of the disc is once saved in the text memory until finalizing the disc. When the text memory is full, *MEMORY FULL* will appear on the display and unable to add more text data. If you want to add more text data, you have to finalize the text data for each disc in order to obtain memory space or erase the entire memory following the operation below.

- ① Press ■ **STOP** (5) of the CDR deck or CDR (43).
- ② Press **MENU/STORE** (18, 44) on the deck or the remote control to enter Menu mode.
- ③ Rotate **MULTI JOG** (21) to select the **TEXT VIEW** submenu.  
*TEXT VIEW* appears on the display.
- ④ Press **PUSH ENTER** (21) or **ENTER** (53) on the remote control to confirm.

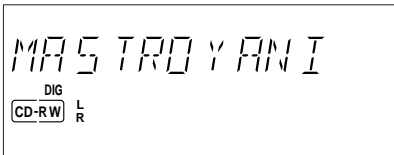

- ⑤ Select the disc you wish to erase.
- ⑥ Press **PUSH ENTER** (21) or **ENTER** (53) on the remote control to confirm.  
*ERASE MEMORY* appears on the display.



- ⑦ Press the **PUSH ENTER** (21) or **ENTER** (53) on the remote control to confirm the erasure of the text for that particular disc.
- ⑧ Press **MENU/STORE** (18, 44) to return to the submenu or ■ **STOP** (5) to exit.

### Note:

- If there are no discs in the memory, the message *MEMORY EMPTY* appears on the display.
- *MEMORY FULL/FINALIZE CD* may also appear when unfinalizing a CD-RW disc for which text was stored (see 'Unfinalizing CD-RW discs' page 14.). The same action(s) should be taken in order to obtain memory space.

## Recording settings

- When Auto Track is ON, track numbers will automatically be increase during the recording.
- You can adjust the right and left volume balance during the recording.

## Auto track increment

- ① Press ■ **STOP** (5) of the CDR deck or CDR (43).
- ② Press **MENU/STORE** (18, 44) on the deck or the remote control to enter Menu mode.
- ③ Rotate **MULTI JOG** (21) to select the **AUTO TRACK** submenu.  
*AUTO TRACK* appears on the display.
- ④ Press **PUSH ENTER** (21) or **ENTER** (53) on the remote control to confirm.
- ⑤ Select Auto track *ON* or *OFF* by rotating **MULTI JOG** (21).



- ⑥ Press **PUSH ENTER** (21) or **ENTER** (53) on the remote control to confirm.
  - When *ON* is selected, track numbers will be automatically incremented during recording.
  - When *OFF* is selected, you can number the recorded tracks yourself. The track number is increased by pressing the **TRACK INCR.** (49) on the remote.
- ⑦ Press **MENU/STORE** (18, 44) to store settings and return to the submenu or ■ **STOP** (5, 48) to exit.

## Balance (Only active in Record/Standby mode)

- ① Press **MENU/STORE** (18, 44) to enter Menu mode.
- ② Rotate **MULTI JOG** (21) to select the **SET BALANCE** submenu.  
*SET BALANCE* appears on the display.



- ③ Press **PUSH ENTER** (21) or **ENTER** (53) on the remote control to confirm.  
→ *L 100 R 100* appear on the display.
- ④ Adjust the internal and external recording balance by turning the **MULTI JOG** (21).
- ⑤ Press **PUSH ENTER** (21) or **ENTER** (53) on the remote control to confirm.
- ⑥ Press **MENU/STORE** (18, 44) to store settings.

### Note:

The balance setting will not be stored.



# DISPLAY

Messages, as listed and explained here, may appear on the display for your guidance.

## General

- READING*..... reading disc information
- OPEN*..... during tray opening
- CLOSE*..... during tray closing
- NO DISC*..... no disc inserted, disc unreadable or disc inserted upside down
- PRG FULL*..... program full
- INSERT DISC*..... insert disc or insert disc in correct way
- WRONG DISC*..... inserted disc is no audio CD
- FINALIZE*..... unfinalized CD-R(W) disc
- MEMORY %/0*..... indicates the amount of text memory used for unfinalized discs

## Recording

- WAIT*..... - when ■ STOP is pressed during recording  
- wenn ■ STOP während Aufnahme der ersten 4 Sekunden eines Titels gedrückt wird
- UPDATE*..... updating disc contents
- DISC FULL*..... no more recording possible
- DIGITAL 1*..... digital coaxial input 1 selected
- OPTICAL*..... digital optical input selected
- ANALOG*..... analog input selected
- COPY PROTECT*..... no digital recording can be made of the external source
- NOTFINALIZE*..... when opening the tray with an unfinalized disc inserted (in the CD-Recorder)
- RECORD FAST*..... High Speed recording selected
- REC LISTEN*..... Listen Speed recording selected
- MAKE CD*..... High Speed Recording and Auto Finalize function selected
- REC EXT DISC*..... Synchronised start of recording from external source selected
- REC EXT MAN*..... Manual start of recording from external source selected
- xx*..... level is being adjusted
- DOES NOT FIT*..... time left on CD-R(W) disc is not enough for proposed recording
- ANALOG REC*..... copy prohibited track found during recording. Track will be copied analog (Copy Protection Regulations).
- ERASE TRACK*..... when erasing one or more tracks
- ERASE DISC*..... when erasing a disc
- FINALIZE CD*..... when finalizing a disc
- CHECK INPUT*..... when REC is pressed while no digital source is detected
- xx xx ERASE*..... time countdown when erasing a track or a disc
- xxxx FINAL*..... time countdown when finalizing a disc

- PRESS RECORD*..... to start manual recording, finalizing or erasing
- START SOURCE*..... to start synchronised recording from a source
- FINALIZE*..... when trying to record on a finalized CD-R(W) or a prerecorded CD
- UNFINALIZE*..... when trying to record on a finalized CD-RW
- PRESS ENTER*.....
- PROF SOURCE*..... when a professional source is connected
- REC TEXT*..... when Text copy is available
- TEXT PROTECT*..... when Text copy is unavailable

## Play

- PROGRAM*..... program mode selected
- ALBUM TITLE*..... will be followed by album title
- TRACK TITLE*..... will be followed by track title
- ALBUM ARTIST*..... will be followed by artist name
- TRACK ARTIST*..... will be followed by track artist name
- SCANNING*..... when unfinalized CD-R(W) disc is inserted in CD deck

## Others

- NO AUDIO TR*..... when the recorder enters a data track during recording
- FINALIZE CD*..... laser power calibration performed 96 times, finalize disc
- INITIALISING*..... during laser power calibration for unfinalized discs
- DISC RECOVER*..... during disc recovering after power failure
- OPC ERROR*..... OPC failure during OPC procedure (OPC = Optimum Power Calibration)
- RECORD ERROR*..... recording error in menu mode
- DISC ERROR*..... when trying to record on or finalize a recovered disc
- MEMORY FULL*..... when text memory is full. To add a CD to the list, first finalize or erase another disc from the list.
- FINALIZE CD*.....

## DISPLAY

### Menu messages

<i>NO TRACK</i> .....	when attempting to edit text for a disc which has no tracks
<i>TEXT EDIT</i> .....	when entering Text Edit mode
<i>CD ARTIST</i> .....	when editing or erasing an artist name
<i>CD TITLE</i> .....	when editing or erasing a title
<i>TR N ARTIST</i> .....	when editing or erasing an artist name per track
<i>TR N TITLE</i> .....	when editing or erasing a title per track
<i>TEXT ERASE</i> .....	when entering Text Erase mode
<i>ALL TEXT</i> .....	when entering All Text mode
<i>ERASE OK</i> .....	when confirmation for erasing has to be given with ENTER key
<i>ERASE ALL OK</i> .....	when confirmation for erasing has to be given with ENTER key
<i>ERASE MEMORY</i> .....	when waiting for confirmation when erasing a disc
<i>TEXT VIEW</i> .....	when selecting text review per unfinalized disc in memory
<i>MEMORY EMPTY</i> .....	when REVIEW is selected while no text is in memory
<i>AUTO TRACK</i> .....	when selecting auto track increment ON or OFF
<i>ON</i> .....	Auto Track increment on
<i>OFF</i> .....	Auto Track increment off
<i>SET BALANCE</i> .....	when selecting BALANCE
<i>NO TEXT</i> .....	no text stored for disc

## OTHER INFORMATIONS

### Fixing problems

If you think your CD-Recorder is defective, it is wise to read this list first. Maybe you forgot a simple step.

#### **Warning!**

**Under no circumstances should you attempt to repair the CD-recorder yourself as this will invalidate the guarantee.**

#### No power

- ensure that the **POWER ON/OFF** (1) button is on: the CD-Recorder is in standby mode, press any button to activate it
- ensure that the power cord is plugged in correctly
- switch the recorder OFF and then immediately back ON

#### Auto track does not work

- check if auto track is selected
- check if there are 2.7 seconds silence in between the tracks (analog recording only)
- check if the source is consumer source with the digital output according to IEC audio standard
- source is DVD disc (no track information)

#### No sound

- check the audio connections
- if using an amplifier, try using a different source

#### Amplifier sound is distorted

- check that the CD-Recorder analog output is not connected to the amplifier PHONE input.

#### Play will not start

- ensure that the label of the CD is facing up
- clean the disc
- check that the disc is not defective by trying another disc

#### Remote control does not work

- point the remote control directly at the CD-Recorder
- check the batteries and replace if necessary
- select the right source first
- check the control selector

#### Will not record

- clean the disc
- check if CD-R(W) is an unfinalised disc
- check that the disc is recordable and replace if necessary
- the disc is not an audio disc (*WRONG DISC*)
- wrong input source chosen. Input label flashing (*CHECK INPUT*)
- text memory full (*MEMORY FULL/FINALIZE CD*). When a CD-RW has to be unfinalised for recording. Erase text for other disc(s) or finalise other disc(s) to obtain memory space.

#### Recording is distorted

- make sure the recording level was not too high

#### 20 second pause between recordings

- see 'RECORDING (from external source)' CD SYNC

## OTHER INFORMATIONS

### Player does not react

- use the **POWER ON/OFF** (1) button on the front of the Player to switch it off and back on

### DISC RECOVER on display

- a power failure has occurred during recording the CD-Recorder is attempting to repair the disc
- If **DISC ERROR** then appears on the display, the disc cannot be recorded further, and cannot be finalised. But it can still be played on the CD-Recorder or another CD-Recorder.
- on a CD-R(W) disc, the track being recorded is lost, but further recording and finalisation can still be done

## ABOUT TEXT

The input text data is saved in the text memory until the disc is finalized. Therefore, the data is not written in the CD-R(W) disc before finalizing the disc.

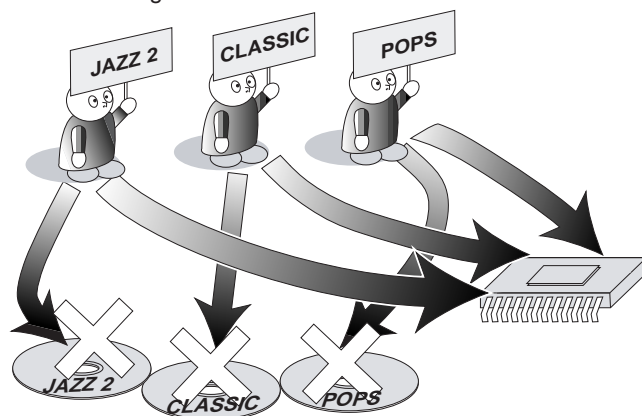

Finalizing the disc transfers the text data from the text memory to the disc.

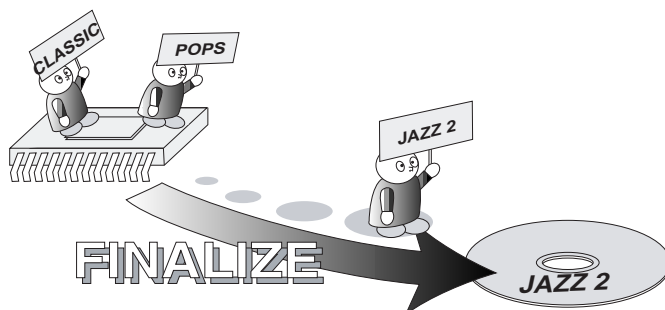

Unfinalizing the disc transfers the text data from the disc to the text memory.

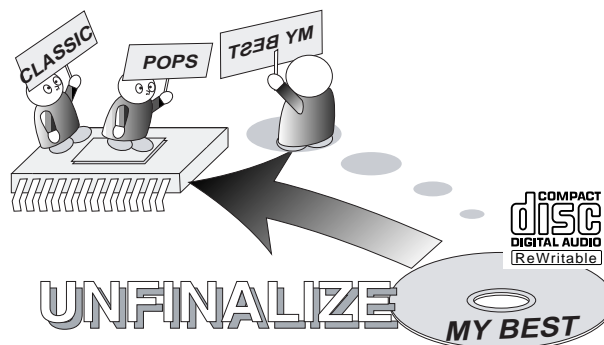

When the text memory is full, **MEMORY FULL** appears on the display and you cannot add more text data.

In this case, you need to make more space in text memory. You can either finalize one or more disc(s) to transfer the text data to each disc, or erase (part of) the text data in the text memory.

### Note:

When the text memory is full depends on the amount of the input text data per disc and the number of discs.

Typically the text memory can store for 50 discs of the text data consisting of 60 characters of an artist name or title for 20 tracks.

# TECHNICAL SPECIFICATIONS

## GENERAL

System .....	Compact disc digital audio
Number of channels .....	2 (stereo)
Applicable discs .....	CD, CD-R (digital audio), CD-RW (digital audio)
Power Requirement .....	AC 230 V 50 Hz
Power Consumption .....	20W
Operating Temperature .....	5 - 35 °C
Dimension (MAX)	
Width .....	420 mm
Height .....	76 mm
Depth .....	309 mm
Weight .....	4.4 Kg

## AUDIO

Frequency Response .....	20 Hz - 20 kHz
Playback S/N .....	100 dB
Playback Dynamic Range .....	96 dB
Playback Total Harmonic Distortion .....	0.003 %
Recording S/N .....	90 dB
Recording Dynamic Range .....	92 dB
Recording Total Harmonic Distortion .....	0.006 %
Digital Coaxial Output .....	0.5 V (p-p)/75 Ω
Line Output Voltage .....	2 V RMS
Digital Optical Output .....	- 20 dBm

### Recording values for line input

Digital Coaxial Input (automatic sample rate conversion) .....	11 - 56 kHz
Digital Optical Input (automatic sample rate conversion) .....	11 - 56 kHz
Analog Input .....	600 mVrms/ 50 kΩ

Specifications subject to change without prior notice.

COUNTRY	COMPANY	ADDRESS
ALGERIE	Azur 2000	8, Lotissement Ben Hatadi, Alger, Algeria
ARMENIA	NGYIG Ltd.	47 A/75 St. Lalaïants, 375000 Yerevan, Armenia
AUSTRALIA	Jamo Australia Pty. Ltd.,	24 Lionel Road, Mt. Waverley, VIC 3149, Australia
AUSTRIA	Huber & Prohaska GmbH	Taborstraße 95 / Ladestraße 1, Gebäude Hangartner, A-1200 Wien, Austria
BAHREIN	Ambassador Stores	P.O. Box 237,141, Government Avenue, Manama, Bahrein
BANGLADESH	Target	1078, Ramjoy Mohanja Lane Asadgonj, Chittagong 4000, Bangladesh
BELGIUM	Van der Heyden Audio N.V.	Brusselbaan 278, 9320 Erembodegem, Belgium
BULGARIA	Ariescommerce GmbH	Makedonia Blvd. 16, 1606 Sofia, Bulgaria
CANADA	Lenbrook Industries Limited	633 Granite Court, Pickering, Ontario
CHINA	Guang Chang Audio International Co., Ltd.	No.38 Yushan Road, ShiQiao, Pan Yu, Guang Dong, China
CYPRUS	Empire Hifi systems Ltd.	P.O. Box 5604, Nicosia, Cyprus
CZECH REPUBLIC	Audio International	Sokolska 41, 67902 Rajecsko, OKR,Blansko, Czech Republic
DENMARK	Audio Nord	Dali Allé 1, 9610 Noerager, Denmark
DUBAI	V.V.& SONS	P.O. Box 105, Dubai, U.A.E.
EGYPT	Solimco	9, El Attibaa St. Doki, Cairo, Egypt
ESTONIA	HiFi Club Estonia	Ehte 4, 90503 Haapsalu, Estonia
F.Y.R.O.M.	T.P. KODI	ul.Cedomir Kantargiev 21a, Skopje, Former Yugoslavian Republic of Macedonija
FINLAND	Audio Nord	Uudenmaankatu 4-6, Helsinki SF-00120, Finland
FRANCE	Marantz France	A division of Marantz Europe B.V., P.O. Box 301, 92 156 Suresnes Cedex, France
GERMANY	Marantz Deutschland	Hakenbusch 3, 49078 Osnabrück, Germany
GREECE	Adamco S.A.	188, Hippocratous Street, 11471 Athens, Greece
HEADQUARTERS EUROPE:	Marantz Europe B.V.	Building SFF-2, P.O. Box 80002, 5600 JB Eindhoven, The Netherlands
HONG KONG	Marantz Asia Ltd.	Unit 1706, Metroplaza II, 223 Hing Fong Road, Kwai Fong, N.T., Kowloon, Hong Kong
HUNGARY	Infovox Ltd.	Terez Krt.31, 1067 Budapest, Hungary
ICELAND	ID Electronics Ltd.	Armula 38, 108 Reykjavik, Iceland
INDIA	NOVA Audio Private	8,Punam Co-op.Society 29/30 Road#5, Union Park MUMBAI 400052, India
IRAN	Home Co.	5th floor no 878 Philips Building Enghelab ave, P.O. 11365/7844 Tehran, Iran
IRELAND	Marantz Ireland	Clonskeagh, Dublin 14, Ireland
ISRAEL	Elmor Ltd.	52 Heh Beiyar Street, Kikar Hamedina, Tel Aviv, Israel
ITALY	Marantz Italy	Via Casati 23, 20052 Monza (Milano), Italy, Servizio Consumatori 1678-20026, Numero Verde
IVORY COAST	Hifivoir	B.P. 2428, Abidjan 01, Ivory Coast
JAPAN	Marantz Japan Inc.	35-1 Sagami Ohno 7-Chome, Sagamihara-shi, Kanagawa 228-8505, Japan
KOREA	Mk Enterprises Ltd.	121-210, 2F Shinhan Bldg., 247-17 Seokyo-dong, Mapo-ku, Seoul, Korea
KUWAIT	alAlamiah Electronics Intl.	P.O. Box 8196, Salmiah 22052, Kuwait
LATVIA	Ace Ltd.	61, LacPlesa Str., Riga LV 1011, Latvia
LEBANON	AZ Electronics S.A., 1,	P.O. Box 11 2833, Beirut, Lebanon
LITHUANIA	Accapella Ltd.	Ausros, Vartu G/5, Pasazo SKG., 2001 Vilnius, Lithuania
MALAYSIA	Wo Kee Hong Electronics Sdn. Bhd.	102 Jalan SS 21/35, Damansara Utama, 47400 Petaling Jaya, Selangordarul Ehsan, Malaysia
MALTA	Doneo Co Ltd.	78 The Strand, Sliema SLM07, Malta
MAURITIUS	SKR Electronics Ltd.	P.O. Box 685, Bell Village, Port Louis, Mauritius
MILITARY MARKET EUROPE	PASCO GmbH	PO BOX 1280, Sandhausen 69200, Germany
NETHERLANDS	Marantz Domestic Sales	A division of Marantz Europe B.V., Building SFF2, P.O. Box 80002, 5600 JB Eindhoven, The Netherlands
NEW ZEALAND	Wildash Audio Systems	14 Malvern Road, Mt. Albert, Auckland, New Zealand
NORWAY	Audio Nord	Sandkerveien 64, Oslo 0483, Norway
OMAN	Mustafa & Jawad Trading CO.	P.O. Box 1918, Ruwi, Oman
POLAND	Philips Polska Sp. z.o.o.	Al.Jerozolimskie 195b, 02 222 Warszawa, Poland
PORTUGAL	Corel2	Comércio de Electrónica Lda., Av. Luís Bivar, No 85 A, 1050 Lisboa, Portugal
PROFESSIONAL EUROPE	Marantz Professional Products	Kingsbridge House, Padbury Oaks, 575-583 Bath Road, Longford, Middlesex UB7 0EH, U.K.
PROFESSIONAL U.S.A.	Marantz Professional Products	Distributed by: Superscope Technologies Inc., 1000 Corporate Blvd. Ste.D, Aurora, Illino
QATAR	Almana & Partners W.W.L.	P.O. Box 49, Doha, Qatar
REUNION	Vision +	180 Rue du Marechal Leclerc, 97400 Saint Denis, Ile de la Reunion
ROMANIA	Nova Music Entertainment	5, Zagazului Str. Bl.1G,apt.18, sector 1,Bucharest, Romania
RUSSIA	Absolute Audio	7/2, Montazhnaya Street, 107497 Moscow, Russia
SAUDI ARABIA	Adawlia Univ. Electr. Apl	P.O. Box 2154, Alkhobar 31952, Saudi Arabia
SINGAPORE	Forward Marketing (S) Pte. Ltd.	Wo Kee Hong Centre, 29 Leng Kee Road, Singapore 159099, Singapore
SLOVAKIA	Bis Audio s.r.o.	Nam. SNP 10, 96001 Zvolem, Slovakia
SLOVENIA	Bofex	Smartinska 152, HALA V/3, 61000 Ljubljana, Slovenia
SOUTH AFRICA	Coherent Imports (PTY) Ltd.	P.O. Box 1614, Alberton, 1450, South Africa
SPAIN	Marantz Spain	Martinez Villergas 2, Apartado 2065, Madrid 28027, Spain
SRI LANKA	The listening Room	Mezzanine Floor, The Landmark 385, Galle Road, Colombo - 3, Sri Lanka
SWEDEN	Audio Nord	Almedalsvagen 4, Gotenborg 402-23, Sweden
SWITZERLAND	Sound Company AG	Postfach, 8010 Zürich, Switzerland
SYRIA	Hamzeh & Partners	Hafez Ibrahim Str. No 117, Damascus Shalan, Syria
TAHITI	Covecolor	Av. Prince Hinoi, Cours de l'union sacré, P.O. Box 2334, Papeete, Tahiti
TAIWAN	Pai-Yuing Co. Ltd.	6th No 148 Sung Kiang Road, Taipei 10429, Taiwan R.O.C.
THAILAND	MRZ Standard Co. Ltd.	746-750 Mahachai Road, Wangburapa, Bangkok 10200, Thailand
TUNESIA	Societe EDEVIG	40, Avenue du Golfe Arabe, El Menzah, 1004, Tunesia
TURKEY	Türk Philips Ticaret A.S.	Yukari Dudullu Organize sanayi Bolgesi, 2.Cadde no.28, 81260 Umraniye-Istanbul, Turkey
U.K.	Marantz Hifi UK Ltd.	Kingsbridge House, Padbury Oaks, 575-583 Bath Road, Longford, Middlesex UB7 0EH, U.K.
U.S.A.	Marantz America Inc.	440 Medinah Road, Roselle, IL 60172, U.S.A.
YUGOSLAVIA	ITM Company	Omladinskih Brigada 86, 11070 Belgrade, Yugoslavia
EXPORT	Marantz Domestic Sales	A division of Marantz Europe BV, Building SFF2, P.O. Box 80002, 5600 JB Eindhoven, TheThe Netherlands

www.marantz.com

**marantz**® is a registered trademark.

